

El Corte Inglés

---

# APLIQUE ARTICUS

MOD. ART0735-ECI

REF.450-01695

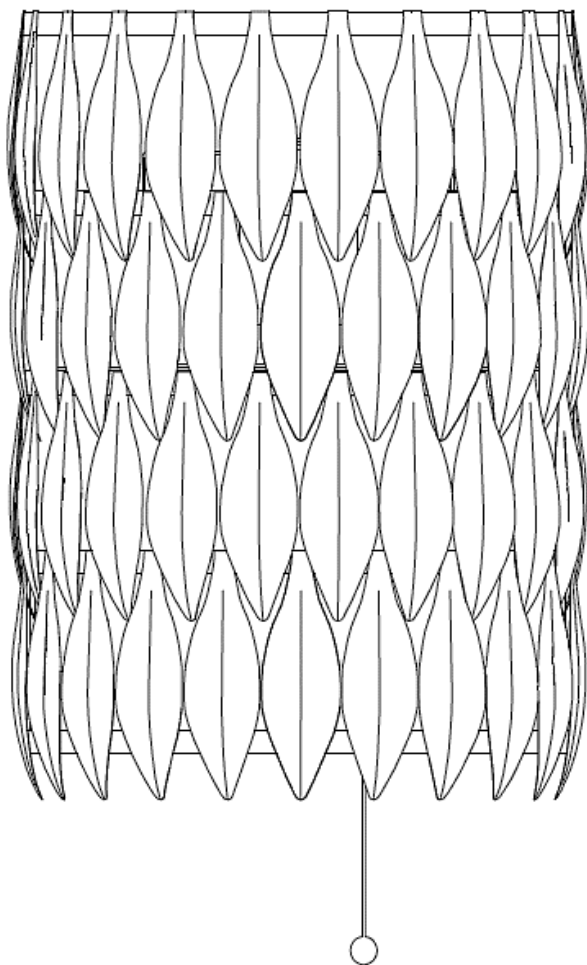

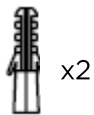

x2

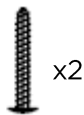

x2

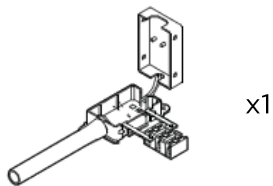

x1

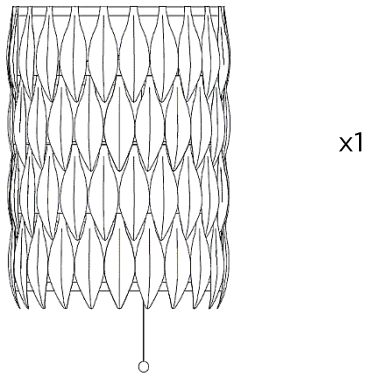

x1

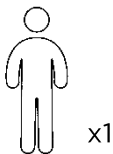

x1

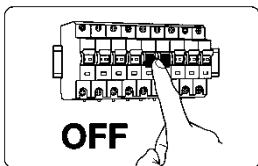
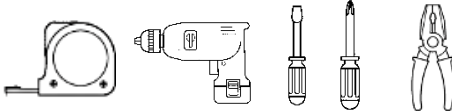

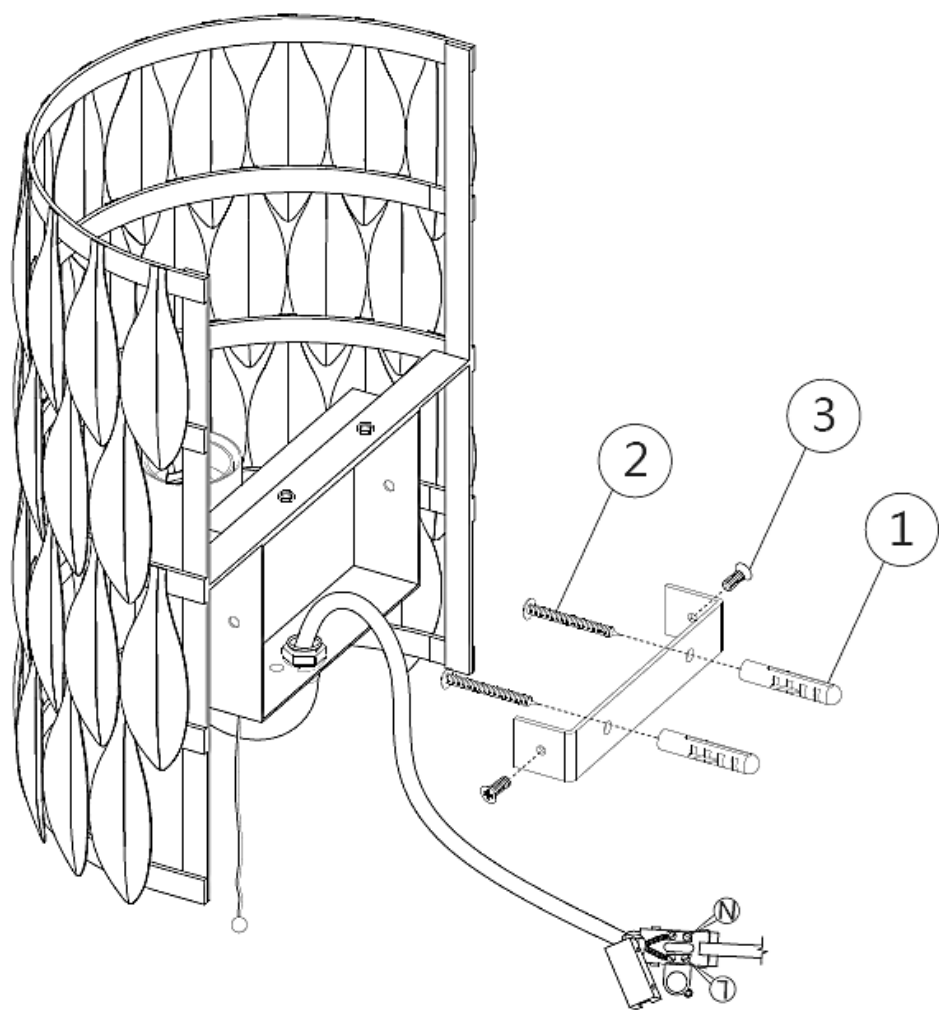



---

1x40W max  
E14  
230V ~ 50Hz  
No incluida - Não incluida  
Not included



---

Uso Interior  
Uso Interior  
Indoor use



---

Requiere instalación  
Necessita instalação  
Requires installation

---

Este dispositivo debe colocarse de acuerdo con las normativas de cableado y edificación aplicables: Ciertas normativas requieren que un dispositivo solo pueda ser instalado por un técnico cualificado, asegúrese de estar familiarizado con los requisitos aplicables en su país o zona. Si tiene alguna duda, compruébelo antes de intentar la instalación para evitar riesgos innecesarios.

Al cambiar las bombillas, desconecte siempre la corriente principal y deje que la bombilla antigua se enfríe antes de manipularla. Deseche con cuidado las bombillas. Para algunas bombillas, por ejemplo, las fluorescentes, las condiciones de desecho son especiales.

Este dispositivo deve ser instalado de acordo com os regulamentos de ligações eléctricas e de construção relevantes: Alguns regulamentos obrigam a que um dispositivo só possa ser instalado por um electricista qualificado, certifique-se de que está familiarizado com os requisitos do seu país ou estado. Em caso de dúvida, consulte antes de qualquer tentativa de instalação para evitar riscos desnecessários.

Quando mudar as lâmpadas, desligue sempre da rede eléctrica e deixe a lâmpada antiga arrefecer antes de manusear. Elimine cuidadosamente as lâmpadas. Algumas lâmpadas (por exemplo, fluorescentes) requerem procedimentos de eliminação especiais.

This fitting should be fitted in accordance with relevant wiring and building regulations: Certain regulations require that a fitting can only be installed by a qualified electrician ensure you are familiar with the requirements in your Country or State. If in doubt, check prior to any attempt at installation to avoid unnecessary risk.

When changing bulbs, always switch off at the mains and allow the old bulb to cool down before handling. Dispose of bulbs carefully. Some bulbs (e.g. fluorescent) require special disposal.

---

## El Corte Inglés S.A.

Hermosilla 112, - 28009 Madrid

España / Espanha / Spain

NIF: A-28017895

Fabricado en / na China / Made in China

[clientes@elcorteingles.es](mailto:clientes@elcorteingles.es)

