

Laundry Combo

User manual

WD18DB8995**

SAMSUNG

Contents

Safety information	4
What you need to know about the safety instructions	4
Important safety symbols	4
Important safety precautions	5
Critical installation warnings	8
Installation cautions	9
Critical usage warnings	10
Usage cautions	11
Critical cleaning warnings	15
Care for preventing freezing	15
Instructions about the WEEE	16
INFORMATION PURSUANT TO ART. 13 LAW DECREE n. 123/2023 (Applicable for Italia only)	17
Installation	18
What's included	18
Installation requirements	21
Step-by-step installation	23
Before you start	30
Initial setup	30
Run Calibration (recommended)	30
Laundry guidelines	31
Detergent recommendation	33
Detergent drawer guidelines	34
Operations	40
LCD panel	40
Operating a cycle	43
Cycle overview	44
Settings	48
Special features	55
SmartThings	56
Open Source Announcement	58

Maintenance	60
Product Care	60
Self Clean+	61
Self Dry	62
Emergency drain	63
Cleaning	65
Defrosting your washing machine	75
Care against an extended time of disuse	75
Troubleshooting	76
Checkpoints	76
Information codes	82
Specifications	84
Fabric care chart	84
Protecting the environment	85
Standby power consumption	86
Refrigerant safety precautions	86
Spare parts guarantee	86
Specification sheet	87
Contact information	89
QUESTIONS OR COMMENTS?	89

Safety information

Congratulations on your new Samsung Laundry Combo. This manual contains important information on the installation, use and care of your appliance. Please take some time to read this manual to take full advantage of your Laundry Combo's many benefits and features.

What you need to know about the safety instructions

Please read this manual thoroughly to ensure that you know how to safely and efficiently operate the extensive features and functions of your new appliance. Please store the manual in a safe location close to the appliance for future reference. Use this appliance only for its intended purpose as described in this instruction manual.

Warnings and Important Safety Instructions in this manual do not cover all possible conditions and situations that may occur. It is your responsibility to use common sense, caution and care when installing, maintaining and operating your Laundry Combo.

Because the following operating instructions cover various models, the characteristics of your Laundry Combo may differ slightly from those described in this manual and not all warning signs may be applicable. If you have any questions or concerns, contact your nearest service center or find help and information online at www.samsung.com.

Important safety symbols

What the icons and signs in this user manual mean:

WARNING

Hazards or unsafe practices that may result in **severe personal injury, death and/or property damage**.

CAUTION

Hazards or unsafe practices that may result in **personal injury and/or property damage**.

Read the instructions

After reading this manual, store it in a safe place for future reference.

Read all instructions before using the appliance.

NOTE

Indicates that a risk of personal injury or material damage exists.

These warning signs are here to prevent injury to yourself and others.

Please follow them explicitly.

As with any equipment that uses electricity and moving parts, potential hazards exist. To safely operate this appliance, familiarize yourself with its operation and exercise care when using it.

Important safety precautions

To reduce the risk of fire, electric shock, or injury to persons when using your appliance, follow basic precautions, including the following:

1. This appliance is not intended for use by persons (including children) with reduced physical, sensory or mental capabilities, or lack of experience and knowledge, unless they have been given supervision or instruction concerning use of the appliance by a person responsible for their safety.
2. **For use in Europe:** This appliance can be used by children aged from 8 years and above and persons with reduced physical, sensory or mental capabilities or lack of experience and knowledge if they have been given supervision or instruction concerning use of the appliance in a safe way and understand the hazards involved. Children shall not play with the appliance. Cleaning and user maintenance shall not be made by children without supervision.
3. Children should be supervised to ensure that they do not play with the appliance.
4. If the supply cord is damaged, it must be replaced by the manufacturer, its service agent or similarly qualified persons in order to avoid a hazard.
5. **CAUTION:** In order to avoid a hazard due to inadvertent resetting of the thermal cut-out, this appliance must not be supplied through an external switching device, such as a timer, or connected to a circuit that is regularly switched on and off by the utility.

Safety information

6. The new hose-sets supplied with the appliance are to be used and that old hose-sets should not be reused.
7. This appliance is intended to be used in household only and it is not intended to be used such as:
 - staff kitchen areas in shops, offices and other working environments;
 - farm houses;
 - by clients in hotels, motels and other residential type environments;
 - bed and breakfast type environments;
 - areas for communal use in blocks of flats or in launderettes.
8. For appliances with ventilation openings in the base, that a carpet must not obstruct the openings;
9. **For use in Europe:** Children of less than 3 years should be kept away unless continuously supervised.

NOTE

From the number 10 through the end of the list are only applicable for models with a drying function.

10. The tumble dryer is not to be used if industrial chemicals have been used for cleaning.
11. The lint trap has to be cleaned frequently, if applicable.
12. Lint must not to be allowed to accumulate around the tumble dryer.
(not applicable for appliances intended to be vented to the exterior of the building)

-
13. Adequate ventilation has to be provided to avoid the back flow of gases into the room from appliances burning other fuels, including open fires.
 14. Do not dry unwashed items in the tumble dryer.
 15. Items that have been soiled with substances such as cooking oil, acetone, alcohol, petrol, kerosene, spot removers, turpentine, waxes and wax removers should be washed in hot water with an extra amount of detergent before being dried in the tumble dryer.
 16. Items such as foam rubber (latex foam), shower caps, waterproof textiles, rubber backed articles and clothes or pillows fitted with foam rubber pads should not be dried in the tumble dryer.
 17. Fabric softeners, or similar products, should be used as specified by the fabric softener instructions.
 18. The final part of a tumble dryer cycle occurs without heat (cool down cycle) to ensure that the items are left at a temperature that ensures that the items will not be damaged.
 19. Remove all objects from pockets such as lighters and matches.
 20. **WARNING:** Never stop a tumble dryer before the end of the drying cycle unless all items are quickly removed and spread out so that the heat is dissipated.
 21. **WARNING:** The appliance must not be supplied through an external switching device, such as a timer, or connected to a circuit that is regularly switched on and off by a utility.

Safety information

22. Exhaust air must not be discharged into a flue which is used for exhausting fumes from appliances burning gas or other fuels.
23. The appliance must not be installed behind a lockable door, a sliding door or a door with a hinge on the opposite side to that of the tumble dryer, in such a way that a full opening of the tumble dryer door is restricted.

Critical installation warnings

WARNING

The installation of this appliance must be performed by a qualified technician or service company.

- Failure to do so may result in electric shock, fire, an explosion, problems with the appliance, or injury.

The appliance is heavy, therefore take care when lifting it.

Plug the power cord firmly into a wall socket that meets local electrical specifications. Use the socket for this appliance only, and do not use an extension cord.

- Sharing a wall socket with other appliances using a power strip or extending the power cord may result in electric shock or fire.
- Ensure that the power voltage, frequency, and current are the same as those of the product specifications. Failure to do so may result in electric shock or fire.

Remove all foreign substances such as dust or water from the power plug terminals and contact points using a dry cloth on a regular basis.

- Unplug the power plug and clean it with a dry cloth.
- Failure to do so may result in electric shock or fire.

Plug the power plug into the wall socket so that the cord is running towards the floor.

- If you plug the power plug into the socket in the opposite direction, the electric wires within the cable may be damaged and this may result in electric shock or fire.

Keep all packaging materials out of the reach of children as these may be dangerous.

- If a child places a bag over its head, it may suffocate.

When the appliance, power plug or power cord is damaged, contact your nearest service center.

This appliance must be properly grounded.

Do not ground the appliance to a gas pipe, plastic water pipe, or telephone line.

- This may result in electric shock, fire, an explosion, or problems with the appliance.
- Never plug the power cord into a socket that is not grounded correctly and make sure that it is in accordance with local and national regulations.

Do not install this appliance near a heater or any inflammable material.

Do not install this appliance in a humid, oily or dusty location, or in a location exposed to direct sunlight or water (raindrops).

Do not install this appliance in a location exposed to low temperatures.

- Frost may cause the tubes to burst.

Do not install this appliance in a location where gas may leak.

- This may result in electric shock or fire.

Do not install or keep the product exposed to the outdoor elements.

Do not use an electric transformer.

- This may result in electric shock or fire.

Do not use a damaged power plug, damaged power cord or loose wall socket.

- This may result in electric shock or fire.

Do not pull or excessively bend the power cord.

Do not twist or tie the power cord.

Do not hook the power cord over a metal object, place a heavy object on the power cord, insert the power cord between objects, or push the power cord into the space behind the appliance.

- This may result in electric shock or fire.

Do not unplug the appliance by pulling the power cord.

- Unplug the power plug by holding the plug.
- Failure to do so may result in electric shock or fire.

This appliance should be positioned so that the power plug, the water supply taps, and the drain pipes are accessible.

Following the repair by a non-authorized service provider, self-repair or non-professional repair of the product, Samsung is not liable for any damage to the product, any injury or any other product safety issue caused by any attempt to repair the product which does not carefully follow these repair and maintenance instructions. Any damage to the product caused by an attempt to repair the product by any person other than a Samsung certified service provider will not be covered by the warranty.

Installation cautions

CAUTION

Install your appliance on a solid, level floor that can support its weight.

- Failure to do so may result in abnormal vibrations, movement, noise, or problems with the appliance.

Safety information

Critical usage warnings

WARNING

If the appliance is flooded, turn off the water and power supplies immediately and contact your nearest service center.

- Do not touch the power plug with wet hands.
- Failure to do so may result in electric shock.

If the appliance generates a strange noise, a burning smell, or smoke, unplug the power cord immediately and contact your nearest service center.

- Failure to do so may result in electric shock or fire.

In the event of a gas leak (such as propane gas, LP gas, etc.), ventilate immediately without touching the power plug. Do not touch the appliance or power cord.

- Do not use a ventilating fan.
- A spark may result in an explosion or fire.

Remove all door levers before disposing of the appliance.

- If trapped inside the appliance, children may suffocate to death.

Make sure to remove the packaging (sponge, styrofoam) attached to the bottom of the Laundry Combo before using it.

Do not wash items contaminated with gasoline, kerosene, benzene, paint thinner, alcohol or other inflammable or explosive substances.

- This may result in electric shock, fire or explosion.

Do not open the door by force while operating.

- Water flowing out of the Laundry Combo may result in burns or cause the floor to be slippery. This may result in injury.
- Opening the door by force may result in damage to the appliance or injury.

Do not sit on the appliance or lean against the doors.

- The appliance may fall over causing a serious injury.

Dry the laundry only after it was spun by an appropriate washing machine.

Do not dry laundry contaminated by inflammable materials such as gasoline, kerosene, benzene, thinner, alcohol, etc.

- This may result in electric shock, fire or explosion.

Do not touch the power plug with wet hands.

- This may result in electric shock.

Do not turn the appliance off by unplugging the power cord while an operation is in progress.

- Plugging the power cord into the wall socket again may cause a spark and result in electric shock or fire.

Do not let children climb in or onto the appliance.

- This may result in electric shock, burns or injury.

Do not insert your hand or a metal object under the Laundry Combo while it is operating.

- This may result in injury.

Do not unplug the appliance by pulling the power cord. Always grip the plug firmly and pull it straight out of the outlet.

- Damage to the power cord may cause a short-circuit, fire and/or electric shock.

Do not attempt to repair, disassemble, or modify the appliance yourself.

- Do not use a fuse (such as copper, steel wire, etc.) other than a standard fuse.
- When the appliance needs to be repaired or reinstalled, contact your nearest service center.
- Failure to do so may result in electric shock, fire, problems with the appliance, or injury.

If the water supply hose comes loose from the water tap and floods the appliance, unplug the power cord.

- Failure to do so may result in electric shock or fire.

Unplug the power cord when the appliance is not being used for long periods of time or during a thunder or lightning storm.

- Failure to do so may result in electric shock or fire.

If any foreign substance enters into the appliance, unplug the power cord and contact your nearest Samsung Customer Service.

- This may result in electric shock or fire.

Keep your pets away from the appliance to prevent them from chewing any parts of the Laundry Combo, which may result in electric shock, fire, or injury.

Usage cautions

CAUTION

When the Laundry Combo is contaminated by a foreign substance such as detergent, dirt, food waste, etc., unplug the power cord and clean the Laundry Combo using a damp, soft cloth.

- Failure to do so may result in discoloration, deformation, damage, or rust.

The glass parts may break by a strong impact. Take care when using the Laundry Combo.

- If the glass is broken, it may result in injury.

Open the water tap slowly after a long period of non-use, water supply failure, or when reconnecting the water supply hose.

- The air pressure in the water supply hose or the water pipe may damage a part of the appliance or result in a water leak.

If a draining error occurs during an operation, check if there is a draining problem.

- If the Laundry Combo is used when it is flooded because of a draining problem, it may result in electric shock or fire.

Insert the laundry into the Laundry Combo completely so that the laundry does not get caught in the door.

- If laundry gets caught in the door, it may result in damage to the laundry or the appliance, or result in a water leak.

Safety information

Turn the water supply off when the Laundry Combo is not being used.

- Ensure that the screws on the water supply hose connector are properly tightened.

Ensure that the rubber seal and front door glass are not contaminated by a foreign substance (such as waste, thread, hair, etc.).

- If a foreign substance is caught in the door or the door is not completely closed, it may cause a water leak.

Open the water tap and check if the water supply hose connector is firmly tightened and that there is no water leak before using the appliance.

- If the screws on the water supply hose connector are loose, it may result in a water leak.

The appliance you have purchased is designed for domestic use only.

Using the appliance for business purposes qualifies as an appliance misuse. In this case, the appliance will not be covered by the standard warranty provided by Samsung and no responsibility can be attributed to Samsung for malfunctions or damages resulting from such misuse.

Do not stand on the appliance or place objects (such as laundry, lighted candles, lighted cigarettes, dishes, chemicals, metal objects, etc.) on the appliance.

- This may result in electric shock, fire, problems with the appliance, or injury.

Do not spray volatile material such as insecticide onto the surface of the appliance.

- As well as being harmful to humans, this may result in electric shock, fire or problems with the appliance.

Do not place objects that generate electromagnetic fields near the Laundry Combo.

- This may result in injury due to a malfunction.

Water drained during a high-temperature wash or drying cycle is hot. Do not touch the water.

- This may result in burns or injury.

Draining time may vary depending on the water temperature. If the water temperature is too high, the draining process starts after the water cools down.

Do not wash, spin, or dry water-proof seats, mats, or clothing (*) unless your model has a special cycle for these items.

(*): Woollen bedding, rain covers, fishing vests, ski pants, sleeping bags, diaper covers, sweat suits, and bicycle, motor cycle and car covers, etc.

- Do not wash thick or hard mats even if the washing machine mark is on the care label. This may result in injury or damage to the Laundry Combo, walls, floor, or clothing due to abnormal vibrations.
- Do not wash throw rugs or doormats with rubber backing. The rubber backing may come off and stick to inside the drum, and this may result in malfunction such as a drainage error.

Do not operate the Laundry Combo when the detergent drawer is removed.

- This may result in electric shock or injury due to a water leak.

Do not touch the insides of the drum during or just after drying as it is hot.

- This may result in burns.

Do not touch the inside of the glass door and the drum after washing and drying as those parts may become hot and could cause burns.

Do not insert your hand into the detergent drawer.

- This may result in injury as your hand may be caught by the detergent input device.

Remove the liquid detergent guide (applicable models only) when using powdered detergent.

- If not, water may leak through the front of the detergent drawer.

Do not place any objects (such as shoes, food waste, or animals) other than laundry into the Laundry Combo.

- This may result in damage to the Laundry Combo, or injury and death in the case of pets because of the abnormal vibrations.

Do not press the buttons using sharp objects such as pins, knives, fingernails, etc.

- This may result in electric shock or injury.

Do not wash or dry laundry contaminated by oils, creams or lotions usually found in skincare shops or massage clinics.

- This may cause the rubber seal to become deformed and result in a water leak.

Do not leave metal objects such as safety pins or hairpins in the drum for long periods of time.

- This may cause the drum to rust.
- If rust starts appearing on the surface of the drum, apply a (neutral) cleansing agent to the surface and use a sponge to clean it. Never use a metal brush.

Do not use dry cleaning detergent directly and do not wash, rinse, or spin laundry contaminated by dry cleaning detergent.

- This may result in spontaneous combustion or ignition due to the heat from the oxidation of the oil.

Do not use water from water cooling/heating devices.

- This may result in problems with the Laundry Combo.

Do not use natural hand-washing soap for the Laundry Combo.

- If it hardens and accumulates inside the Laundry Combo, it may result in problems with the appliance, discoloration, rust, or bad odors.

Place socks and brassieres in a washing net and wash them with the other laundry.

Do not wash large laundry items such as bedding in the washing net.

- Failure to do so may result in injury due to abnormal vibrations.

Do not use hardened detergent.

- If it accumulates inside the Laundry Combo, it may result in a water leak.

Make sure that the pockets of all the clothing items are empty.

- Hard, sharp objects such as coins, safety pins, nails, screws, or stones can cause extensive damage to the appliance.

Do not wash or dry clothing with large buckles, buttons, or other heavy metal objects.

Safety information

Sort the laundry by color on the basis of its colorfastness and select the recommended cycle, water temperature and additional functions.

- This may result in discoloration or fabric damage.

Take care that children's fingers are not caught in the door when closing it.

- Failure to do so may result in injury.

To prevent odours and mould, leave the door open after completing a cycle to allow the drum to dry.

To prevent limescale build-up, leave the detergent drawer open after a wash cycle and dry inside it.

Do not dry laundry containing forming rubber (latex) or similar rubber textures.

- If forming rubber is heated, it may start a fire.

If necessary, use the laundry net for small and lightweight laundry such as fabric tie belts, apron strings, and underwire bras which can break during a cycle.

Dryer sheets are compatible with this model, and are recommended for better drying performance.

Dryer sheets are also beneficial in reducing the static electricity generated during a drying cycle. Static electricity could lead to damaging laundry items and potentially the appliance.

Do not use the Laundry Combo near dangerous powders such as coal dust, wheat flour, etc.

- This may result in electric shock, fire or explosion.

Do not touch the rear side of the appliance during or immediately after drying is complete.

- The appliance remains hot and may cause burns.

Critical cleaning warnings

WARNING

Do not clean the appliance by spraying water directly onto it.

Do not use a strong acidic cleaning agent.

Do not use benzene, thinner or alcohol to clean the appliance.

- This may result in discoloration, deformation, damage, electric shock or fire.

Before cleaning or performing maintenance, unplug the appliance from the wall socket.

- Failure to do so may result in electric shock or fire.

Clean the filter case before and after using the Laundry Combo.

Clean the inside of the product on a regular basis by asking an authorized service engineer.

Care for preventing freezing

WARNING

Install the Laundry Combo in an area where the temperature does not drop below a water-freezing temperature.

If draining directly using a long drain hose, water remaining inside the hose can freeze in winter. Make sure there is no water left inside the hose after use.

If the drain hose has frozen, wrap the hose with a towel soaked in warm water for approximately ten minutes to thaw it.

Safety information

Instructions about the WEEE



Correct Disposal of This Product (Waste Electrical & Electronic Equipment)

(Applicable in countries with separate collection systems)

This marking on the product, accessories or literature indicates that the product and its electronic accessories (e.g. charger, headset, USB cable) should not be disposed of with other household waste at the end of their working life. To prevent possible harm to the environment or human health from uncontrolled waste disposal, please separate these items from other types of waste and recycle them responsibly to promote the sustainable reuse of material resources.

Household users should contact either the retailer where they purchased this product, or their local government office, for details of where and how they can take these items for environmentally safe recycling.

Business users should contact their supplier and check the terms and conditions of the purchase contract. This product and its electronic accessories should not be mixed with other commercial wastes for disposal.

For information on Samsung's environmental commitments and product regulatory obligations, e.g. REACH, visit our sustainability page available via www.samsung.com

Product disposal in France



FR
Cet appareil et ses accessoires se recyclent

REPRISE À LA LIVRAISON À DÉPOSER EN MAGASIN À DÉPOSER EN DÉCHÈTERIE

Points de collecte sur www.quefairedemesdechets.fr
Privilégiez la réparation ou le don de votre appareil !

FR
ÉLÉMENTS D'EMBALLAGE + LIVRET + FEUILLE

Séparez les éléments avant de trier

INFORMATION PURSUANT TO ART. 13 LAW DECREE n. 123/2023 (Applicable for Italia only)

Pursuant to article 13 D.L. n.123/2023, converted with amendments with Law n. 159/2023, Samsung Electronics Italia S.p.A. informs you that parental control applications are available in relation to this device.

We remind parents and those who exercise parental responsibility of the importance of activating and using parental control applications in order to increase the digital safety of minors, limiting and controlling access to digital content and the internet via this device. Activating parental control applications is free.

For more information on parental control applications, we invite you to consult the websites of the Presidency of the Council of Ministers - Department of Family Policies and of the Communications Regulatory Authority: <https://famiglia.governo.it/it/politiche-e-attivita/famiglia/parental-control/> and www.agcom.it/parental-control.

Installation

What's included

Make sure all the parts are included in the product package. If you have a problem with the Laundry Combo or the parts, contact a local Samsung customer center or retailer.

NOTE

The appearance of the actual product may differ from the image shown.

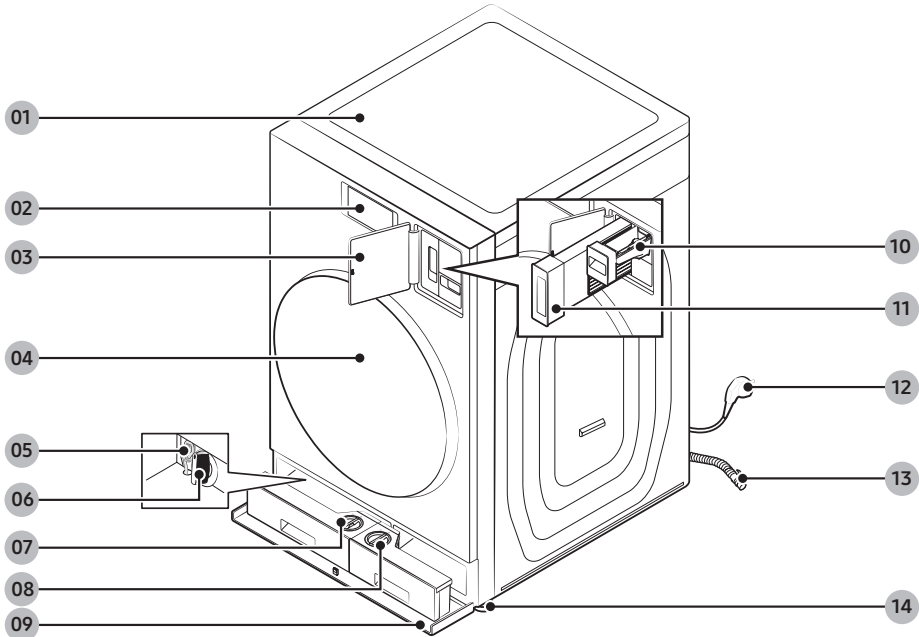

01 Worktop

02 LCD panel

03 Lint filter cover

04 Door

05 Emergency drain tube

06 Drain filter

07 Auto dispenser

08 Flex auto dispenser

09 Compartment cover

10 Manual softener dispenser

11 Lint filter

12 Power plug

13 Drain hose

14 Levelling feet

Accessories (supplied)



Spanner



Bolt caps

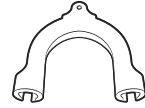

Hose guide
(applicable models only)



Aqua stop hose



Hot water hose

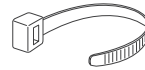

Cable tie



Drain hose
(applicable models only)



Aqua Pebble

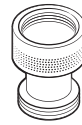

Check valve

Parts sold separately



Appliance Brush *

Installation

NOTE

- Spanner: For removing the shipping bolts and levelling the washing machine.
- Bolt caps: For covering the holes after removing the shipping bolts. The provided number of bolt caps (3 to 6) depends on the model.
- Hose guide: For hanging the drain hose in the drainpipe or wash-basin.
- Cold/Hot water hose: For supplying water to the washing machine. (Hot water hose is for applicable models only.)
- * Appliance brush: Purchase a flexible cleaning brush designed to bend for cleaning the heat exchanger. (Minimum length: 680 mm)
 - Water hoses and appliance brushes are not sold in Samsung service center or retailers.

Installation requirements

Electrical supply and grounding

- Use an individual branch circuit specific to the Laundry Combo.

To ensure proper grounding, the Laundry Combo comes with a power cord featuring a three-prong grounding plug for use in a properly installed and grounded outlet.

Check with a qualified electrician or service person if you are not sure about the grounding. Do not modify the provided plug. If it does not fit the outlet, call a qualified electrician to install a suitable outlet.

WARNING

- Do NOT use an extension cord.
- Use only the power cord that comes with the Laundry Combo.
- Do NOT connect the ground wire to plastic plumbing, gas lines, or hot water pipes.
- Improperly connected grounding conductors may cause electric shock.
- Do not remove or modify the grounding pin of power cord to reduce the risk of electric hazard.
- Please use the additional grounding wire provided with this appliance if there is no hole for earth pin in power inlet socket.

Water supply

A proper water pressure for this Laundry Combo is between 50 kPa and 1000 kPa. Water pressure less than 50 kPa may cause the water valve to not close completely, or it may take longer to fill the drum, causing the Laundry Combo to turn off. Water taps must be within 120 cm from the rear of the Laundry Combo so that the provided inlet hoses reach the Laundry Combo.

To reduce the risk of leaks:

- Make sure water taps are easily accessible.
- Turn off the taps when the Laundry Combo is not in use.
- Check for any leaks at the water inlet hose fittings on a regular basis.

CAUTION

Before using the Laundry Combo for the first time, check all connections at the water valve and taps for any leaks.

Drain

Samsung recommends a standpipe 60-90 cm high. The drain hose must be connected through the hose clip to the standpipe, and the standpipe must fully cover the drain hose.

Installation

Flooring

For best performance, the Laundry Combo must be installed on a solid floor. Wood floors may need to be reinforced to minimise vibration and/or unbalanced loads. Carpeting and soft tile surfaces do not resist vibration well and may cause the Laundry Combo to move slightly during the spin cycle.

CAUTION

Do NOT install the Laundry Combo on a platform or a poorly supported structure.

Water temperature

Do not install the Laundry Combo in areas where water may freeze as the Laundry Combo always retains some water in its water valves, pumps, and/or hoses. Frozen water left in the connection parts may cause damage to belts, the pump, and other components of the Laundry Combo.

Alcove installation

Minimum clearance for stable operation:

Sides	25 mm
Top	25 mm
Rear	50 mm
Front	550 mm

If the Laundry Combo is installed in the same location with other washer or dryer, the front of the alcove must have at least a 550 mm unobstructed air opening.

Step-by-step installation

STEP 1 Select a location

Location requirements:

- A solid, level surface without carpeting or flooring that may obstruct ventilation
- No direct sunlight
- Adequate room for ventilation and wiring
- Ambient temperature always higher than the freezing point (32 °F / 0 °C)
- Away from heat sources

STEP 2 Remove the shipping bolts

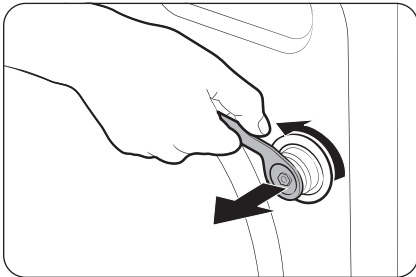

1. After unpacking the product, remove all shipping bolts.

 **NOTE**

Use the enclosed end of the supplied wrench to remove the shipping bolts.

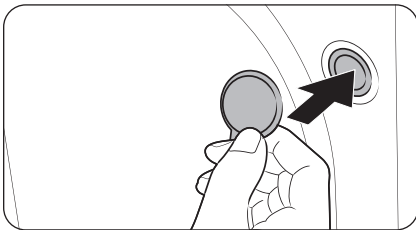

2. Fill the holes with the supplied plastic bolt caps. Keep the shipping bolts for future use.

 **WARNING**

- The shipping bolts secure the tub during product transportation and reduce the chance of suspension damage. Remove the shipping bolts before using the product and only reinsert them if you need to move the product.
- Packaging materials can be dangerous to children. Dispose all packaging material (plastic bags, polystyrene, etc.) out of children's reach.

Installation

STEP 3 Adjust the levelling feet

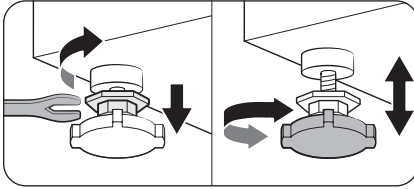

1. Gently slide the Laundry Combo into position. Excessive force may damage the levelling feet.
2. Level the Laundry Combo by manually adjusting the levelling feet.

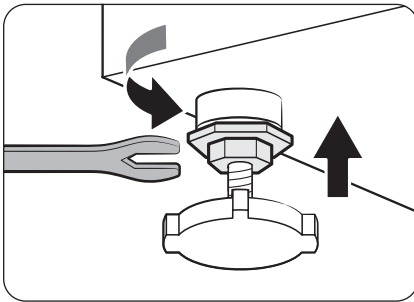

3. When levelling is complete, tighten the nuts using the spanner.

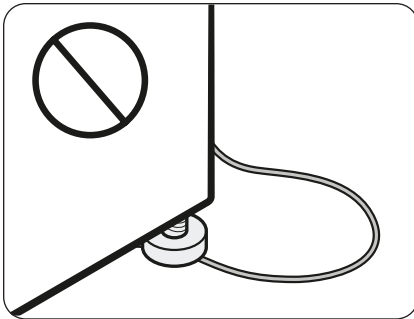

⚠ CAUTION

When installing the product, make sure one of the levelling feet is not pressing the power cord.

⚠ CAUTION

Make sure all the levelling feet are seating on the floor surface to avoid the Laundry Combo from moving or generating noise caused by vibration. Then, check if the Laundry Combo is rocking. If the Laundry Combo is not rocking, tighten the nuts.

STEP 4 Connect the water hose

The provided water hose may differ depending on the model. Please follow the instructions according to the provided water hose.

Connecting to a threaded water tap

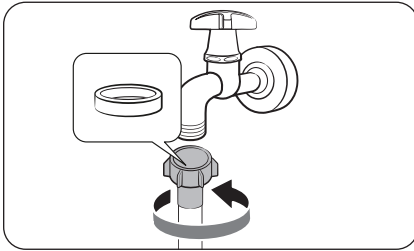

1. Connect the water hose to the water tap, and then turn it to the right to tighten.

⚠ CAUTION

Before connecting the water hose, make sure there is a rubber washer in the hose connector. Do not use the hose if the washer is damaged or missing.

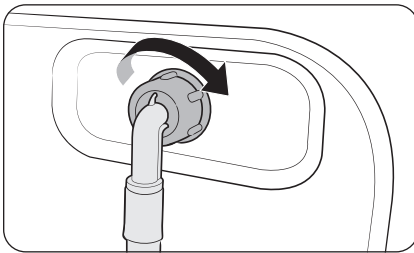

2. Connect the other end of the water hose to the inlet valve on the back of the Laundry Combo, and then turn it to the right to tighten.

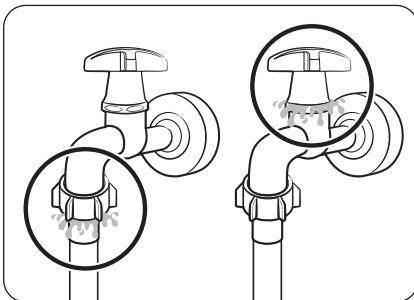

3. Slowly open the water tap and check if there are any leaks around the connection areas. If there are water leaks, repeat step 1 and 2.

⚠ WARNING

If there is a water leak, stop operating the Laundry Combo and disconnect it from the electrical supply. Then, contact a local Samsung service centre in case of a leak from the water hose, or contact a plumbing technician in case of a leak from the water tap. Otherwise, this may cause electric shock.

Installation

⚠ CAUTION

Do not stretch the water hose by force. If the hose is too short, replace the hose with a longer, high-pressure hose.

Connecting to a non-threaded water tap

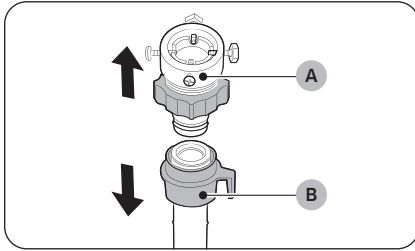

1. Remove the **adaptor (A)** from the water **hose (B)**.

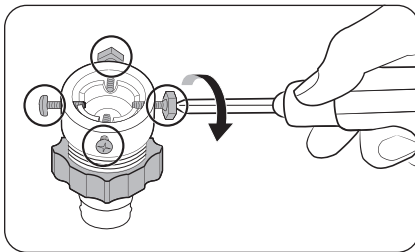

2. Use a Phillips screwdriver to loosen four screws on the adaptor.

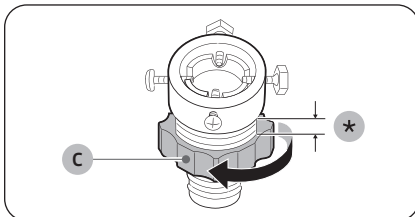

3. Hold the adaptor and turn **part (C)** in the arrow direction to loosen it by 5 mm (*).

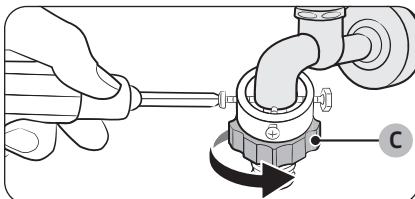

4. Insert the adaptor onto the water tap, and then tighten the screws while lifting the adaptor.
5. Turn **part (C)** in the arrow direction to tighten it.

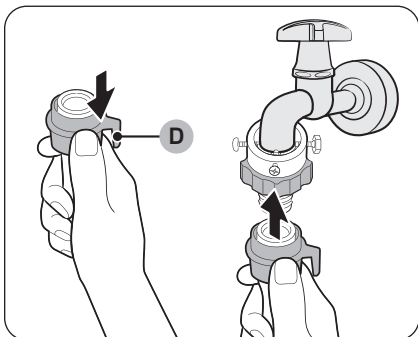

6. While pulling down **part (D)** on the water hose, connect the water hose to the adaptor. Then, release **part (D)**. The hose fits into the adaptor with a clicking sound.

7. To complete connecting the water hose, see 2 and 3 on the “**Connecting to a threaded water tap**” section.

NOTE

- After connecting the water hose to the adaptor, pull the water hose down to check if it is connected properly.
- Use a popular type of water tap. If the tap is square-shaped or too big, remove the spacer ring before inserting the tap into the adaptor.

For models with an additional hot water inlet:

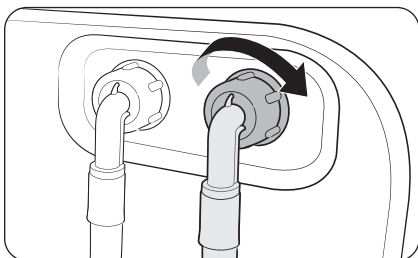

1. Connect the red end of the hot water hose to the hot water inlet on the back of the Laundry Combo.
2. Connect the other end of the hot water hose to the hot water tap.

Installation

Check valve (applicable models only)

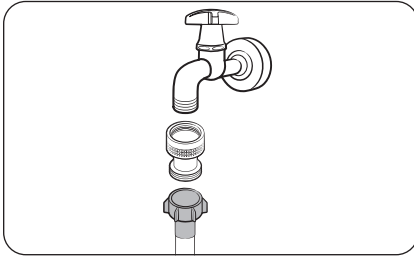

Before connecting the water hose to a water tap, connect the supplied check valve to the water tap and then connect the water hose.

Aqua stop hose (applicable models only)

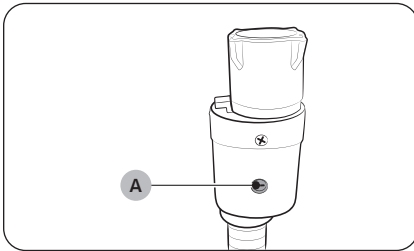

The aqua stop hose alerts users of a risk of water leaks. It senses the water flow and turns red on the centre **indicator (A)** in case of a leak.

NOTE

The end of the aqua stop hose must be fitted to the water tap and not the Laundry Combo.

STEP 5 Position the drain hose

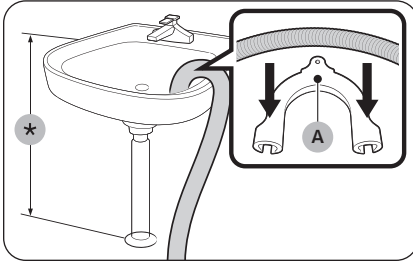

Over the edge of a wash basin

The drain hose must be placed between 60 cm and 90 cm (*) above from the floor. To keep the spout of the drain hose bent, use the supplied **plastic hose guide (A)**. Secure the guide to the wall using a hook to ensure stable drainage.

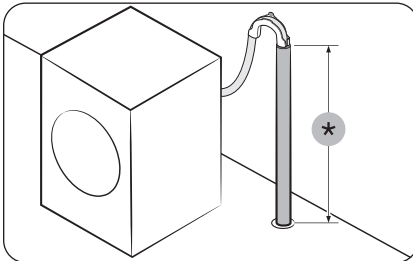

In a drain pipe

The drain pipe should be between 60 cm and 90 cm high (*). It is advisable to use a 65 cm high vertical pipe.

- To ensure the drain hose stays in position, use the plastic hose guide provided (see the figure).
- To prevent the siphoning of water flow during drainage, make sure to insert the drain hose 15 cm into the drain pipe.
- To prevent the drain hose from moving around, secure the hose guide to the wall.

Drain standpipe requirements:

- Minimum diameter of 5 cm
- Minimum carry-away capacity of 60 litres per minute

STEP 6 Power on

Plug the power cord into a wall socket protected by a fuse or circuit breaker. Then, tap  to turn on the Laundry Combo.

Before you start

Initial setup



- When you turn on the Laundry Combo for the first time, the screen shows the initial setup process. Follow the on-screen instructions to complete it.
- Once you select a language, the language selection screen will not reappear. However, you must complete a wash cycle once to stop the tutorial screen from reappearing.
 - You can change the language from the Settings menu. On the Home screen, tap **Settings > General > Language** to change the language.
- The initial setup includes language selection and a brief tutorial.
- Tap **OK** to skip to the next screen.

NOTE

If the initial setup screen does not appear during the first use of the product, it does not indicate a problem with the product. You can adjust the desired settings by selecting **Settings > General** from the Home screen, or reset the product to try running the initial setup process by selecting **Settings > General > Reset > Reset all settings**.

Run Calibration (recommended)

Calibration ensures accurate weight detection by the Laundry Combo. Make sure the drum is empty before running calibration.

1. Tap  to turn the power on.
2. Tap  > **Washer > Calibration**.
3. Tap **Start Calibration** to start the calibration.

Laundry guidelines

STEP 1 Sort

Sort the laundry according to these criteria:

- Care Label: Sort the laundry into cottons, mixed fibres, synthetics, silks, wools, and rayon.
- Colour: Separate whites from colours.
- Size: Mixing different sized items together in the drum improves the washing performance.
- Sensitivity: Wash delicate items separately. For pure, new woolen items, curtains, and silk items, check the labels on the items.

 **NOTE**

Make sure to check the care label on all clothing, and sort clothing accordingly before starting the wash.

STEP 2 Empty pockets

Empty all the pockets of your laundry items

- Metal objects such as coins, pins, and buckles on clothing may damage other laundry items as well as the drum.

Turn clothing with buttons and embroideries inside out

- If trousers or jacket zippers are open while washing, the drum may be damaged. Zippers should be closed and fixed with a string.
- Clothing with long strings may become entangled with other clothes. Make sure to tie the strings before starting the wash.

STEP 3 Use a laundry net

- Brassieres (water washable) must be placed in a laundry net. Metal parts of the brassieres may break through and tear other laundry items.
- Small, light clothing such as socks, gloves, stockings, and handkerchiefs may become caught around the door. Place them inside a fine laundry net.
- Do not wash the laundry net by itself without other laundry. This may cause abnormal vibrations that could move the Laundry Combo and result in injury.

Before you start

STEP 4 Determine the load capacity

Do not overload the Laundry Combo. Overloading may cause the Laundry Combo to wash improperly.

NOTE

When washing bedding or bedding covers, the wash time may be lengthened or the spin efficiency may be reduced.

For bedding or bedding covers, the recommended maximum spin level is Low or Medium, and the load capacity is 3.0 kg or less.

CAUTION

- Unbalanced laundry may reduce the spinning performance.
- Make sure the laundry is fully inserted in the drum and not caught in the door.
- Do not slam the door. Close the door gently. Otherwise, the door may not be closed properly.

STEP 5 Apply a proper detergent type

The type of detergent depends on the type of fabric (cotton, synthetic, delicate items, wool), colour, wash temperature, and degree of soiling. Make sure to use the laundry detergent that is designed for automatic washing machines.

NOTE

- Follow the detergent manufacturer's recommendations based on the weight of the laundry, the degree of soiling, and the hardness of the water in your local area. If you are not sure about the water's hardness, contact a local water authority.
- Do not use detergent that tends to be hardened or solidified. This detergent may remain after the rinse cycle, blocking the drain outlet.

CAUTION

When washing wool using the Wool cycle, use a detergent dedicated to wool items. If used with the Wool cycle, powder detergent may remain on the laundry and discolour the laundry.

Detergent recommendation

The recommendations apply to the temperature ranges given in the cycle chart.

●	Recommended	▲	Liquid detergent only
-	Not recommended	△	Powder detergent only

Cycle	Detergent			Temp. (°C)
	Universal	Delicates and woollens	Specialist	
ECO 40-60	●	-	-	40~60
Wash+Dry	●	-	-	40~60
Cotton	●	-	-	Cold~60
AI Wash & Dry	●	-	-	Cold~60
Super Speed	-	-	-	Cold~40
Less Microfiber	●	-	-	Cold~40
Bedding	●	-	-	Cold~40
Delicates	-	●	-	30
Wool	-	●	-	Cold~40
Towels	●	-	-	Cold~90
Denim	●	-	-	Cold~40
Shirts	●	-	-	Cold~40
Baby Care	-	-	●	Cold~90
Pet Care	●	-	-	Cold~90
Sanitise	●	-	-	90

Before you start

Detergent drawer guidelines

NOTE

Auto dispensers make laundry easier by dispensing the preset amount of washing agents without you having to pour it in every time, and it could be more economical because the exact amount will be dispensed each time of use, allowing less waste of washing agents.

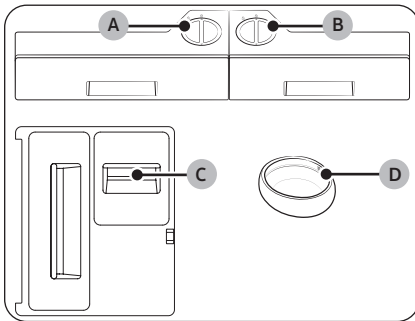

A. Auto dispenser

- You can use the general detergent in this compartment.
- Use liquid detergent only. Do not put powdered detergent or softener.

B. Flex auto dispenser

- You can set this dispenser to dispense detergent (**General detergent** or **Specialty detergent**) or softener.
- Use only neutral detergent in this dispenser if you have set the **Detergent type** to **Specialty detergent**.
- Do not put powdered detergent.

C. Manual softener compartment

- Apply additives such as fabric softener. Do not exceed the max line.

D. Aqua Pebble

- To use the Aqua Pebble, set the **Amount** option for **Auto dispenser** and **Flex auto dispenser** to **Off**.
- Do not use the Aqua Pebble for bleach or fabric softener.

CAUTION

- Do not operate the Laundry Combo without the dispensers in the detergent drawer.
 - A water leak may cause electric shock or injury.
- Do not use the following types of detergent in the drawer.
 - Tablet, capsule, ball, or net types.
- Do not use gel-type or viscous detergent/softener in the detergent drawer as they may not flow well.
 - Read the detergent/softener manufacturer's instructions before using them in the Laundry Combo.
- Do not carry around the dispenser removed from the detergent drawer. Put the dispenser back in place.
 - Otherwise, the dispenser may shake and cause the content to spill out.
- Empty the dispensers in the detergent drawer before moving the Laundry Hub to prevent any content from spilling out on the floor.
- Do not use chlorine bleach, which may damage the laundry.

-
- Use caution when inserting the Aqua Pebble as it is supposed to be balanced on top of the laundry at the beginning of the wash. Tipping the Aqua Pebble before the start of a wash may cause detergent residue to remain on the laundry at the end of the wash, causing discoloration of the laundry or reduced washing performance.
 - Before each wash, clean the Aqua Pebble before adding fresh detergent.
 - Do not insert the Aqua Pebble into a folded item or between different laundry items.
 - Do not use liquid or powdered chlorine bleach.
 - Do not put or store cleaning agents such as detergent, bleach, or fabric softener on your Laundry Combo. Wipe up any spills immediately to prevent damage to the Laundry Combo, especially the finish and the LCD panel.

 **NOTE**

- If the message "**Needs refill**" appears on the display, refill the corresponding dispenser.
- The detergent/softener is not automatically dispensed in the **Wool**, **Delicates**, and **Activewear** cycles if the **Detergent type** for **Auto dispenser** and **Flex auto dispenser** are set to **General detergent**. You must use the Aqua Pebble to put the detergent directly into the drum.
 - However, if the **Detergent type** for **Flex auto dispenser** is set to **Specialty detergent**, the detergent will be dispensed automatically.
- Do not exceed the max line when filling detergent and softener.
- It may be hard to open the detergent drawer with just your fingertips. Grab the detergent drawer handle firmly with your hand and pull to open it.
- Push the detergent drawer all the way to the end to close it.
- If you feel the softener scent is weak, set the softener input amount to a higher level.

Before you start

To use softener

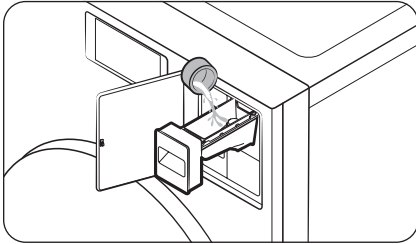

Apply additives such as fabric softener. Do not exceed the max line.

To use Aqua Pebble

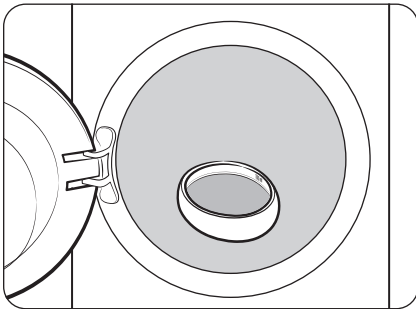

Pour the recommended amount of liquid or powdered detergent (specialty detergent) into the Aqua Pebble, and then put the Aqua Pebble directly into the drum. There are two guidelines inside the Aqua Pebble to indicate 50 ml (1.69 fl oz) and 100 ml (3.38 fl oz). Do not exceed the 100 ml line.

If to apply washing agents to the Auto dispensers

NOTE

If the message "Needs refill" appears on the display, refill the corresponding dispenser.

- The detection time may vary depending on the type of the detergent/softener.

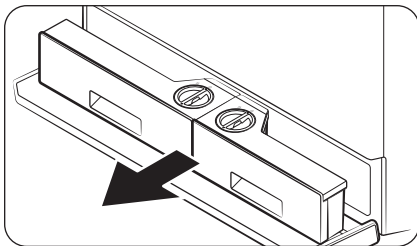

1. Press the Compartment cover to open it.
2. Pull out the Auto dispensers.

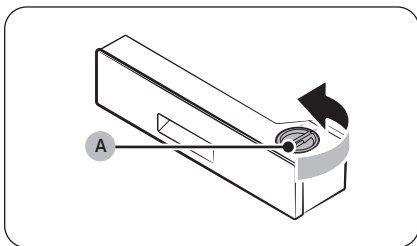

3. Turn the **Auto dispenser cap (A)** counterclockwise to open.

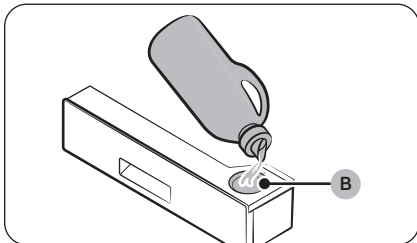

4. Apply an appropriate amount of detergent to the **Auto dispenser (B)**.
 - After you finish, put the cap back and turn it clockwise to close.

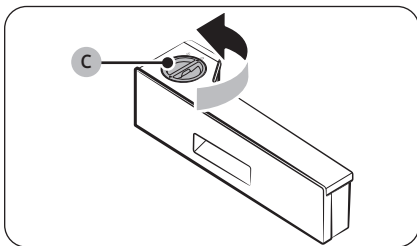

5. Turn the **Flex auto dispenser cap (C)** counterclockwise to open.

Before you start

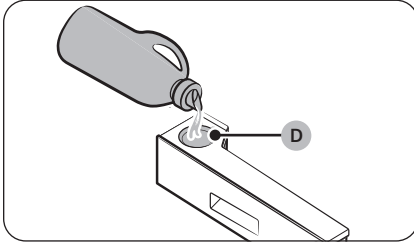

6. Apply an appropriate amount of detergent (General detergent or Specialty detergent) or softener to the **Flex auto dispenser (D)**.
 - After you finish, put the cap back and turn it clockwise to close.

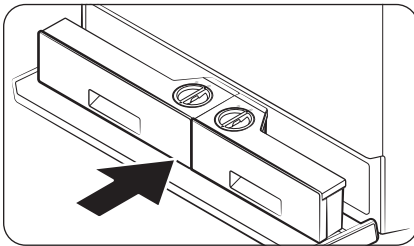

7. Push the Auto dispensers back into their positions.
8. Close the Compartment cover.

Dispenser care

You can check the detergent type used in each dispenser.

NOTE

On the Dispenser care screen, the current status of detergent and fabric softener is displayed and will alert you if any of the dispensers are running low. Follow the on-screen instructions to refill the detergent or fabric softener.

1. On the Home screen, tap **Dispenser care** to move to the Dispenser care screen.
2. Check the amount of detergent in each dispenser and fill the dispenser if the amount is low.
3. Tap  to move to the Home screen.

Operations

⚠ WARNING





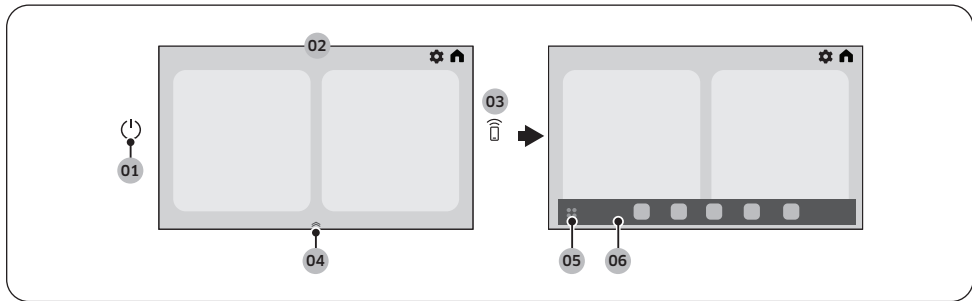



To reduce the risk of fire, electric shock, or injury to persons, read the **Safety information** section before operating this Laundry Combo.

LCD panel







01 Power	Tap to turn the Laundry Combo on or off.
02 Display	The display shows current cycle information and estimated time remaining, or an information message when a problem occurs.
03 Smart Control	Tap to activate or deactivate the Smart Control function. Touch and hold to enter pairing mode to connect to the SmartThings app. <ul style="list-style-type: none"> When the Smart Control function is activated, you can control your Laundry Combo remotely using the SmartThings app on your smartphone or tablet (Android or iOS). For more information on Smart Control, see page 55.
04 App dock handler	Drag the App dock handler upward to open the App dock. <ul style="list-style-type: none"> The App dock handler only appears on the Home screen.
05 App tray button	Tap to view all available apps. <ul style="list-style-type: none"> App drawer: Tap App tray to open App drawer. You can open the App drawer to quickly open the SmartThings, Timer, Bixby, Weather, Ring, Internet, or Settings app.
06 App dock	App dock displays the icons to allow easier access to the frequently used apps. <ul style="list-style-type: none"> Maximum five icons are displayed in the App dock and they are editable.

Display icon descriptions

	Home	Tap to go to the Home screen.
	Settings	Tap to enter the Settings menu. <ul style="list-style-type: none"> For more information on Settings, see page 48.
	Door Lock	<ul style="list-style-type: none"> This icon indicates the door is locked and cannot be opened. The door locks automatically during a cycle and this icon turns on. You can open the door when this icon disappears.
	Smart Control	<ul style="list-style-type: none"> This icon indicates that the Smart Control is on.
	Microphone	<ul style="list-style-type: none"> This icon indicates that the microphone is on.
	Wi-Fi	<ul style="list-style-type: none"> This icon indicates the signal strength when the Internet connection is active.
 	Washer (Wash Options)	This icon appears during a wash-only cycle or a washing process. You can tap this icon to change the cycle settings. Tap the desired button to change the default wash cycle settings. <ul style="list-style-type: none"> Temp.: Tap to change the water temperature for the selected cycle. Spin: Tap to change the spin speed for the selected cycle. <ul style="list-style-type: none"> Rinse Hold & No Spin: The final rinse process is suspended so that the laundry remains in the water. To unload the laundry, run a drain or spin process. Drain & No Spin: The drum does not spin after the final drain process. Soil: Tap to change the soil level for the current cycle. Detergent: You can select the amount of the detergent to be dispensed during each wash cycle. Softener: You can select the amount of the softener to be dispensed during each wash cycle. Bubble Soak: This function helps remove a wide variety of stubborn stains. With Bubble Soak selected, laundry is thoroughly soaked in water bubbles for effective washing. <ul style="list-style-type: none"> Tap to turn on or off this function.

Operations

	<p>Dryer (Dry Options)</p>	<p>This icon appears during a dry-only cycle or a drying process. You can tap this icon to change the cycle settings.</p> <p>Tap the desired button to change the default dry cycle settings.</p> <ul style="list-style-type: none"> • Dryness: Tap to change the dry level. You can select from 4 different levels, but the available level depends on the selected cycle. • Dry Time: Tap to change the cycle time. <ul style="list-style-type: none"> - Some cycles do not support a time setting. - You can set the drying time between 20 minutes and 240 minutes. However, available drying time depends on the selected cycle. • Dry Prep: After the washing process is complete and before the drying process begins, the Laundry Combo pauses and alerts the user to remove items unsuitable for drying. <ul style="list-style-type: none"> - If you do not tap the pop-up message within the waiting period, the drying process will start automatically after waiting for 10 minutes. - Dry Prep is only available for the cycles that include both washing and drying process. • Wrinkle Prevent: Reduces wrinkles by rotating the drum intermittently after completing the dry cycle. Wrinkle Prevent provides approximately 180 minutes. The load is dry and can be removed at any time during the Wrinkle Prevent cycle. <ul style="list-style-type: none"> - Tap to turn on or off this function.
	<p>Washer and Dryer</p>	<p>This set of icons appears to show that you can set or have already set the wash and dry cycle settings.</p>
	<p>Open Door</p>	<p>Tap this button to open the door.</p> <ul style="list-style-type: none"> • The button deactivates when the door is open and reactivates when the door is closed.
	<p>Start</p>	<p>You can start the operation.</p>
	<p>Pause</p>	<p>You can pause the operation.</p> <ul style="list-style-type: none"> • During the operation, tap the button to pause.

Operating a cycle

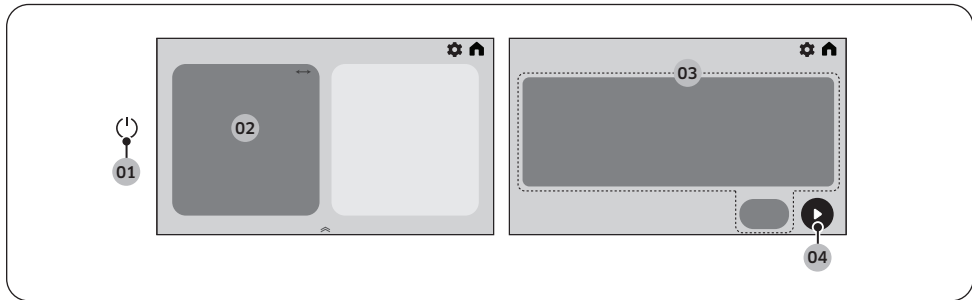

1. Tap to turn the power on.
2. Select the desired cycle.
 - For more information on **Cycle overview**, see page **44**.
3. Change the default cycle options.
 - For the washing process, tap **Temp.**, **Spin**, **Soil**, **Detergent**, **Softener**, **Extra Rinse**, or **Bubble Soak** to change the default cycle settings.
 - For the drying process, tap **Dryness**, **Dry Time**, **Dry Prep**, or **Wrinkle Prevent** to change the default cycle settings.
 - You cannot set the Dry Time for the Time Dry and Cool Air cycle.
 - You can select a wash-only cycle or dry-only cycle.
 - You can set the Delay End function.
 - Not all cycles have additional functions available.
4. Tap to start the operation.
 - Once you set the cycle you want, the screen displays brief cycle descriptions and cycle duration. You can also check the cycle progress, remaining cycle time, and information codes.

NOTE

- To change the cycle, tap **View all**, and then select the desired cycle.
- After the dry cycle ends, the clothes may feel slightly damp or cool to the touch. This is because the combo is designed to dry clothes at low heat in a sealed drum. However, you don't need to worry as the clothes will feel completely dry once you take them out of the drum and shake them.

Operations

Cycle overview

Cycle descriptions

You can add or delete cycles to personalize the cycle list in the My cycles option. For more information, see the **Washer** section on page 52.

NOTE

- If you have finished the wash cycle with a lower Spin setting, the laundry might not be fully dried after the dry cycle. In this case, run the Time Dry cycle additionally.
- To ensure even drying results, you may need to reposition the items in the drum.
- Use the Towels cycle if you need to dry only the towels.

Wash+Dry cycles

Cycle	Description	Max load (kg)
ECO 40-60	<ul style="list-style-type: none">• For cleaning normally soiled cotton items which are declared to be washable at 40 °C or 60 °C, together in the same cycle. This cycle is used to assess the compliance with the EU Ecodesign legislation.• This cycle is set as a default.	Max
Wash+Dry	<ul style="list-style-type: none">• For cleaning normally soiled cotton items which are declared to be washable at 40 °C or 60 °C, together in the same cycle, and to dry them in such a way that it can be immediately stored in a cupboard. This cycle is used to assess the compliance with the EU Ecodesign legislation for wash and dry.	11.0
Cotton	<ul style="list-style-type: none">• For cottons, bed linens, table linens, underwear, towels, or shirts. The washing time and the rinse count are automatically adjusted according to the load.	Max
AI Wash & Dry	<ul style="list-style-type: none">• Adjusts the amount of detergent and the cycle according to the load and the soil severity. This cycle is best used with the Auto dispensers function.	9.0

Cycle	Description	Max load (kg)
Super Speed	<ul style="list-style-type: none"> For less soiled laundry with less than a 5.0 kg load. It takes at least 17 minutes, depending on the conditions such as the water pressure, water hardness, and/or extra options selected. A recommended amount of detergent is less than 20 g (for a 5.0 kg load). 	5.0
Less Microfiber	<ul style="list-style-type: none"> Use this cycle to reduce the amount of microfibers generated during washing synthetic clothes. 	9.0
Bedding	<ul style="list-style-type: none"> For bed spreads, bed sheets, bedding covers, etc. For best results, wash only 1 type of bedding. 	4.0
Delicates	<ul style="list-style-type: none"> For sheer fabrics, bras, lingerie (silk), and other handwash-only fabrics. Using specialty detergent in the Aqua Pebble or Flex auto dispenser is recommended. 	2.0
Wool	<ul style="list-style-type: none"> Specific for machine-washable wool for loads less than 2.0 kg. The Wool cycle features fine pulsating and soaking to protect the wool fibres from shrinkage/distortion. Using specialty detergent in the Aqua Pebble or Flex auto dispenser is recommended. 	2.0
Towels	<ul style="list-style-type: none"> For bath towels, washcloths, and mats. 	5.0
Denim	<ul style="list-style-type: none"> For denim and jeans. Wash inside out. Denim and jeans often contains excess dye and may run during the first few washes. Wash light and dark colored items separately. 	3.0
Shirts	<ul style="list-style-type: none"> For shirts, blouses that are made of cotton, synthetic fiber. 	5.0
Baby Care	<ul style="list-style-type: none"> Featuring a high-temperature wash and extra rinses to help remove the remaining detergent effectively. 	9.0
Pet Care	<ul style="list-style-type: none"> For cleaning pet-related items, stains, or odors, etc. 	1.5

Operations

Cycle	Description	Max load (kg)
Sanitise	<ul style="list-style-type: none">For colorfast fabrics and heavily soiled laundry, this cycle heats the supplied water over 60 °C (140 °F) to clean deeply.If you stop running the cycle while the Laundry Combo is heating the water, the door remains locked for your safety.	9.0
Spin Only	<ul style="list-style-type: none">To perform the spin process only.	-
Rinse+Spin	<ul style="list-style-type: none">Features an additional rinse process after fabric softener is applied to the laundry.	-

Dry cycles

Cycle	Description	Max load (kg)
Air Bedding Care	<ul style="list-style-type: none">For dusting off clothes, bedspreads, bed sheets, and bedding covers, etc.	3.0
Down Jacket Care	<ul style="list-style-type: none">For fluffing up a down jacket.	2.0
Time Dry	<ul style="list-style-type: none">You can set the cycle time from 20 minutes to 240 minutes.	-
Cool Air	<ul style="list-style-type: none">All types of fabric. For freshening up or airing items of laundry that have not been worn for long.	-

Product Care cycles

Cycle	Description	Max load (kg)
Product Care	Self Clean+ (Wash cycle) <ul style="list-style-type: none">• Cleans the drum by removing dirt and build-up from the drum.• Perform once every 40 washes.• Make sure the drum is empty.	-
	Self Dry (Dry cycle) <p>You can sterilize the drum to maintain its cleanliness.</p> <ul style="list-style-type: none">• An alert message to perform the Self Dry cycle appears after every 30 uses. Use this cycle regularly to dry inside the drum and prevent odor.	

NOTE

- Loading the household washing machine or the household washer-dryer up to the capacity indicated by the manufacturer for the respective cycles will contribute to energy and water savings.
- The noise and remaining moisture content are influenced by the spinning speed: the higher the spinning speed in the spinning phase, the higher the noise and the lower the remaining moisture content.
- The most efficient cycle in terms of energy consumption are generally those that perform at lower temperatures and longer duration.



Operations

Settings

Using Settings

1. Tap .
2. Tap **General** or **Washer**.
3. Scroll through the screen to select the desired menu.
4. Change the settings or start the function.

NOTE

- To return to the Home screen, tap  on the top left corner, or  on the top right corner of the screen.
- If the selected function is not supported, the "**Currently not supported**" message is displayed, and the **OK** button is not activated.
- When you select an additional function, a brief help message appears for the first ten times of use.
- The setup sequence may vary depending on the model, and product features are subject to change without prior notice for quality improvement.

Settings menu description

General

Options	Description
Samsung account	You can log in to your Samsung account or create a new Samsung account.
Connections	<p>You can turn the Wi-Fi on or off. You can also start the Smart Control function.</p> <ul style="list-style-type: none"> • Wi-Fi: Tap to turn on or off the Wi-Fi. <ul style="list-style-type: none"> - The Laundry Combo's Wi-Fi is off as a factory default setting. However, the Laundry Combo's Wi-Fi turns on automatically when you turn on the Laundry Combo for the first time. Then, the final Wi-Fi setting is maintained regardless of the Laundry Combo power status. - Once you turn on the Laundry Combo's Wi-Fi and connect to a network, the Laundry Combo remains connected to the network even when you turn off the power. - The Wi-Fi indicates that the Laundry Combo is connected to the router through the Wi-Fi connection. • Easy Connection: You can easily install the SmartThings app using the displayed QR code on the screen. <ul style="list-style-type: none"> - You can connect to the SmartThings app and control your Laundry Combo remotely. • Bluetooth: You can connect with Bluetooth-enabled mobile devices nearby. Once connected through Bluetooth, you can make and receive calls using Bixby.
Lock	<p>You can lock the control of the Laundry Combo to prevent children or infants from accidentally starting or setting the Laundry Combo.</p> <ul style="list-style-type: none"> • When Lock is enabled, the touch screen and the door become locked for safety. • You can enable/disable Lock in any selected cycle. • Press and hold the Unlock button for 3 seconds to unlock. <p>NOTE</p> <ul style="list-style-type: none"> • If you want to put additional items into the Laundry Combo while Lock is enabled, you must disable the Lock function first. • You cannot open the door after a wash cycle when the Lock is on. Disable the function first, and then open the door and take out the laundry. <ul style="list-style-type: none"> - Turn on the power, tap  > General > Lock and set the function to Off. Then, you will be able to open the door.

Operations



Options	Description
Sounds	<p>You can set the Sound mode, Sound theme, Volume, and Voice style.</p> <ul style="list-style-type: none"> • Sound mode: You can set the desired Sound mode from Voice, Tone, and Mute. <ul style="list-style-type: none"> - If you set the Sound mode to Mute, the alert sound will not be turned off for safety purposes. • Sound theme: You can select the desired Sound theme. Tap a theme once to preview the sound. • Volume: You can adjust the volume for system and media sounds. <ul style="list-style-type: none"> - Sound mode will automatically change to Voice if you adjust the volume while the Sound mode is set to Mute. • Voice style: You can select the desired Voice style. Tap a style once to preview the sound.
Home device notifications	You can turn on or off the notifications for your home devices registered on the SmartThings app.
Display	You can set Brightness and Font size.
Avatar	You can select an avatar to assist you with product usage, and the selected avatar will guide you through device usage instructions and key notifications.
Bixby	<p>You can set the Voice wake-up and Sound feedback options.</p> <p> NOTE</p> <ul style="list-style-type: none"> • The microphone for voice recognition is built into the Laundry Combo's worktop. <ul style="list-style-type: none"> - The best way to use the voice recognition function is to stand within 3 feet (1 meter) of the Laundry Combo, reduce any background noise, and speak loudly and clearly at a steady pace toward the built-in microphone. • The voice recognition function may not work if you stand more than 3 feet (1 meter) away or if you speak too softly.
Microphone	You can enable or disable the use of the microphone.
Language	You can change the system language.
Date and time	You can set the time and date automatically or manually and set the desired time format.
Liquid units	You can select the liquid units.

Options	Description
Accessibility	<p>You can set the Screen reader and Visibility enhancements settings.</p> <ul style="list-style-type: none"> • Screen reader: Enable this feature to receive voice feedback from your Laundry Combo. • Visibility enhancements: You can change the High contrast and Text size settings to enhance the visibility.
Software update	<p>You can download and install the latest version of the software. Download begins automatically when the Laundry Combo is connected to Wi-Fi.</p>
Support	<p>You can check the user guide or start the remote support service.</p> <ul style="list-style-type: none"> • Get remote support for all your needs related to your appliance.
Reset	<p>You can reset network settings or reset all settings.</p> <ul style="list-style-type: none"> • Reset network settings: Turn on the power, tap Settings > General > Reset > Reset network settings > Reset in that order. <ul style="list-style-type: none"> - This will reset the Wi-Fi and SmartThings connection settings. • Reset all settings: Turn on the power, tap Settings > General > Reset > Reset all settings > Reset in that order. <ul style="list-style-type: none"> - This will reset all the settings, including network settings and personal data. - Your Laundry Combo resets to the factory setting. • Restart: Restart the device.
About device	<p>You can check the information of the Laundry Combo such as Status and Legal information.</p>

Operations

Washer

Options	Description
Drum light	This turns on the light inside the drum so you can check the status of the items inside.
Auto dispensers	<p>You can select the dispenser mode and set the detergent type, concentration, and amount setting. The Laundry Combo automatically dispenses an adequate amount of detergent for the selected cycle.</p> <ul style="list-style-type: none"> • Dispenser mode: You can select the Dispenser mode. The default setting is General detergent and Softener. <ul style="list-style-type: none"> - You can select General detergent and Softener, General detergent and Specialty detergent, or General detergent and General detergent. • Detergent type <ul style="list-style-type: none"> - Auto dispenser: You can only select General detergent. - Flex auto dispenser: You can set this dispenser to dispense detergent (General detergent or Specialty detergent) or softener. • Concentration: You can change the concentration level. <ul style="list-style-type: none"> - 1x > 2x > 3x - The default setting is 1x. • Amount: You can select the amount of the detergent to be dispensed during each wash cycle. <ul style="list-style-type: none"> - Low > Medium > High - The default setting is Medium. <p> NOTE</p> <ul style="list-style-type: none"> • You can enable and disable automatic detergent dispensing and set the detergent amount to be dispensed for each cycle. You must put detergent manually if you disable the automatic detergent dispensing. • For the cycles that require the use of special detergent, only the available options are displayed.

Options	Description
<p>Pump clean</p>	<p>You can use this function to clean detergent or softener residue buildup in the pump.</p> <p>Use this function after you empty and clean the dispenser.</p> <ul style="list-style-type: none"> You can select from Auto dispenser, Flex auto dispenser, or Auto dispenser/Flex auto dispenser. <ul style="list-style-type: none"> Pour water up to the MAX line in the dispenser, and then tap Start cleaning. <p> NOTE</p> <p>During the pump cleaning process, the drum rotates to drain water. When the pump cleaning process is complete, the water inside the dispenser(s) will drain automatically.</p>
<p>Auto Open Door</p>	<p>You can set the Laundry Combo door to open automatically after the cycle is finished.</p> <ul style="list-style-type: none"> The default setting is Open immediately. However, if you perform only the washing process, the Open 5 mins later setting applies. You can select from Open 5 mins later, or Open immediately. <p> NOTE</p> <ul style="list-style-type: none"> Available options for the Auto Open Door function are active only when the function is on. The options are inactive when the function is off. The Auto Open Door function does not work when Lock is enabled. The door will not open at the end of the cycle if you have enabled the Stay Connect function in the SmartThings app.
<p>AI pattern</p>	<p>This function saves frequently used cycles and settings. When you turn the function on, the Laundry Combo remembers the cycles you use most and their settings (Wash cycles: Temp., Spin, and Soil / Dry cycles: Dryness and Dry Time) and displays them in frequency order.</p> <ul style="list-style-type: none"> The default setting is On. Set it to Off if you do not want to use this function. When you turn off the function, all the saved data resets.
<p>My cycles</p>	<p>Add or remove cycles to create a personal cycle list.</p> <ul style="list-style-type: none"> You can only edit a cycle to create a personal cycle when the Laundry Combo is not operating. <p> NOTE</p> <ul style="list-style-type: none"> The Cotton and Product Care cycle cannot be removed from the list of cycles. You can also edit My cycles in the SmartThings app.

Operations

Options	Description
Freeze Protection (for Malaysia models)	You can run calibration again for accurate weight detection. <ul style="list-style-type: none">• Keep the appliance from freezing in winter.• To use Freeze Protection, ensure the washer is empty and the door is closed.• Supplies and drains water every 15 minutes for 16 hours to prevent the water from freezing. It'll work well when the outside temperature is above -5 °C.
Calibration	You can run calibration again for accurate weight detection. <ul style="list-style-type: none">• Calibration does not start if the door is not closed properly.• The drum rotates clockwise and counterclockwise for about 3 minutes.

Delay End

You can set the Laundry Combo to finish your wash automatically at a later time, choosing a delay of between 5 hours to 24 hours.



1. Select a cycle and change the cycle settings as necessary.
2. Tap **Delay End** at the bottom of the Cycle screen.
3. Set the desired end time, and then tap **OK**.
 - Status shows in the display and the Laundry Combo tumbles the drum to sense the weight of the load (if load sensing is preset for the selected cycle). When load sensing is complete, the display shows the remaining time until the end of the wash cycle.
 - The time at which the operation ends may vary depending on the amount and condition of the laundry items.
 - To cancel Delay End, tap **Stop** to restart the Laundry Combo.

Special features

Smart Control

You can connect to the SmartThings app and control your Laundry Combo remotely.

Connecting your Laundry Combo

1. Download and open the SmartThings app on your smartphone or tablet (Android & iOS).
2. Tap  to turn on the Laundry Combo.
3. Tap and hold 
 - a. The Laundry Combo enters AP mode and connects to your smartphone or tablet.
 - b. Tap  to authenticate your Laundry Combo.
 - c. Once the authentication process is complete, your Laundry Combo is successfully connected to the app.
 - You can use various features available in the SmartThings app.

NOTE

- If your Laundry Combo fails to connect with the SmartThings app, try again.
- Check your router if you experience any Internet connection problem after connecting your Laundry Combo with the SmartThings app.
- If the Wi-Fi is off, tap and hold  > **Connections**, and then turn the Wi-Fi on.
- Turning the Laundry Combo's Wi-Fi on allows you connect to the Laundry Combo through the SmartThings app on your smartphone or tablet, regardless of the power status of the Laundry Combo. However, the Laundry Combo appears offline on the SmartThings app if the Laundry Combo's Wi-Fi is off.
- Close the door before starting the Smart Control function.
- If you use your Laundry Combo for a while without connecting it to the SmartThings app, a pop-up message about Smart Control will show for 3 seconds on 20th, 40th, and 60th use.
- If the Laundry Combo's Wi-Fi is not connected to an AP (access point), the Wi-Fi will turn off when you turn of the power.

Stay Connect

Set up the Stay Connect function in your SmartThings app to keep Smart Control turned on at the end of a cycle. Your Laundry Combo stays connected to the app so you can send additional instructions, whether you are at home or away.

1. If you turn on the Stay Connect function on the SmartThings app, the Laundry Combo will stay in standby power saving mode after completing a cycle.
 - The Stay Connect function will remain active for up to 24 hours if the door remains closed.
2. When the Stay Connect function is active, the Smart Control, Door Lock, and Wi-Fi icons are illuminated on the LCD display.
3. You can conveniently control your Laundry Combo, adding rinse, spin cycles using the SmartThings app.

Operations

NOTE

- The Laundry Combo switches to standby power saving mode when operation is paused even if the machine is not connected to the SmartThings app.
- In some circumstances, only the Door Lock icon may be illuminated.

SmartThings

Wi-Fi connection

On your smartphone or tablet, go to **Settings** and turn on the wireless connection and select an AP (Access Point).

- This appliance supports the Wi-Fi 2.4 GHz and 5 GHz protocols.

Download

On an app market (Google Play Store, Apple App Store, Samsung Galaxy Apps), find the SmartThings app by searching for "SmartThings". Download and install the app on your device.

NOTE

The app is subject to change without notice for improved performance.

Log in

You must first log into SmartThings with your Samsung account. To create a new Samsung account, follow the instructions on the app. You don't need a separate app to create your account.

NOTE

If you have a Samsung account, use the account to log in. A registered Samsung smartphone or tablet user automatically logs in.



To register your appliance to SmartThings

1. Make sure your smartphone or tablet is connected to a wireless network. If not, go to **Settings** and turn on the wireless connection and select an AP (Access Point).
2. Open **SmartThings** on your smartphone or tablet.
3. If a message of "A new device is found.", select **Add**.
4. If no message appears, select **+** and select your appliance in a list of devices available. If your appliance is not listed, select **Device Type** > **Specific Device Model**, and then add your appliance manually.
5. Register your appliance to the SmartThings app as follows.
 - a. Add your appliance to SmartThings. Make sure your appliance is connected to SmartThings.
 - b. When registration is complete, your appliance appears on your smartphone or tablet.

If you're moving out, we recommend you completely wipe the appliance and do a network reset on it before you leave it behind.

If you're moving in, the easiest way to take control and remove the previous user's access is to add it to SmartThings yourself. But if you don't plan on using SmartThings, a network reset should be performed to protect your privacy. In rental properties, there's a regular change of ownership. To ensure resident privacy, Wi-Fi and/or other connectivity settings should be reset at each change of resident. Please refer to factory reset instructions in this manual.



Operations

Open Source Announcement

The software included in this product contains open source software. You may obtain the complete corresponding source code for a period of three years after the last shipment of this product by contacting our support team via <http://opensource.samsung.com> (Please use the "Inquiry" menu.)

It is also possible to obtain the complete corresponding source code in a physical medium such as a CD-ROM; a minimal charge will be required.

The following URL http://opensource.samsung.com/opensource/SMART_AT_051/seq/0 leads to the open source license information as related to this product. This offer is valid to anyone in receipt of this information.



NOTE

- When Wi-Fi is activated, the energy consumption increases in comparison to the values specified in the indicative information.
- Hereby, Samsung declares that this radio equipment is in compliance with Directive 2014/53/EU and with the relevant statutory requirements in the UK. The full text of the EU declaration of conformity and the UK declaration of conformity is available at the following internet address: The official Declaration of conformity may be found at <http://www.samsung.com>, go to Support > Support home and enter the model name.

RF max transmitter power:

Wi-Fi	
Frequency range	Transmitter power (Max)
2412 - 2472 MHz	20 dBm
5120 - 5250 MHz	23 dBm
5250 - 5350 MHz	20 dBm
5470 - 5725 MHz	20 dBm
Bluetooth	
2402 - 2480 MHz	20 dBm

The 5 GHz WLAN function of this equipment may only be operated indoors. This equipment may be operated in all EU countries.

Maintenance

Keep the Laundry Combo clean to prevent deteriorated performance and to preserve its life cycle.

Product Care

The Product Care screen offers maintenance tips to keep your Laundry Combo clean and prolong the product life cycle.

You can check the remaining number of cycles until the next Self Clean+ and Self Dry duration, and start the Self Clean+ or Self Dry cycle.

NOTE

If the Product Care cycle needs to be performed, a guide message will appear on the Home screen. Follow the on-screen instructions to run the Self Clean+ or Self Dry cycle.

1. On the Home screen tap **Product Care** to move to the Product Care screen.
2. Tap **Clean now** or **Start cleaning** under the desired option to start the care cycle.
 - All the options for the Product Care cycle are set automatically.
 - If both the drum and the heat exchanger require cleaning, all the necessary options for the Product Care cycle are set automatically.
3. Tap  to move to the Home screen.

Self Clean+

Certain usage and environmental conditions may result in some residue build-up or odor in the drum. To prevent this build-up or odor and keep the drum fresh and clean, perform the Self Clean+ cycle at least once a month or every 40 cycles. Perform the recommended procedure below when using the Self Clean+ cycle.

1. Tap .
2. On the Cycle screen, select **Product Care > Self Clean+**.
3. Tap **Clean now**.

CAUTION

If there is chlorine bleach left in the drum for an extended period of time, rust can occur.

NOTE

- The water temperature for Self Clean+ is defaulted to Extra Hot. This temperature cannot be changed.
- In the case where residue is present in the drum, add liquid chlorine bleach to the MAX level line in the Manual bleach compartment before starting the Self Clean+ cycle. Do not add the liquid chlorine bleach to the other compartments (This is only the case for Self Clean+ cycle).
- Do not exceed the max line. Do not use or mix any other detergent or chemicals during the Self Clean+ cycle. If necessary, run a Rinse+Spin cycle after the Self Clean+ cycle has completed to help remove any remaining residue.

Self Clean+ reminder

- After every 40 cycles, the Laundry Combo displays the "**Time to run Self Clean+. Press Clean now to start the Product care cycle.**" message for an hour to alert you to run the **Self Clean+** cycle.
- It is recommended to run the cycle regularly for hygienic purposes.
- You will see the **Self Clean+** alert message when the Laundry Combo completes a cycle. If you open the door, the message disappears, and the display shows the **Self Clean+** cycle setting screen automatically. At this time, the LCD panel displays the recommended drying cycle.
- The reminder will appear on the LCD panel for 5 additional consecutive cycles before turning off. The next reminder will not appear until another 40 cycles have been completed.

Maintenance

Self Dry

1. Tap .
2. On the Cycle screen, select **Product Care** > **Self Dry**.
3. Tap **Clean now**.
 - When you start the Self Dry cycle, the calibration process is included in the cycle to enable more precise weight detection.
 - If you leave the door open after the Self Dry cycle is completed, it helps maintain hygiene inside the Laundry Combo.
 - After every 30 uses, an alert message to perform the Self Dry cycle appears. Use this cycle regularly to dry inside the drum and prevent odor.

 **CAUTION**

Make sure to empty the drum before using this cycle.

Emergency drain

In case of a power failure, drain the water inside the drum before taking out the laundry.

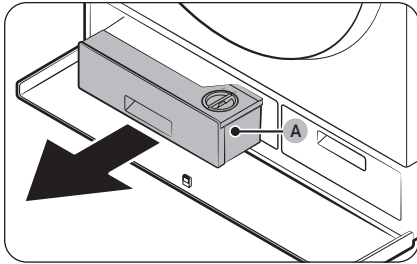

1. Turn off the Laundry Combo, and then unplug the power cord.
2. Press the Compartment cover to open it.
3. Pull out the **Auto dispenser (A)**.

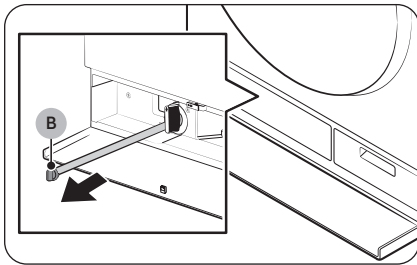

4. Put an empty, spacious container around the cover, and stretch the emergency drain tube to the container while holding the **tube cap (B)**.

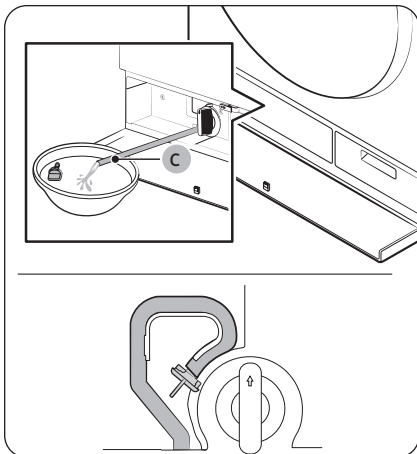

5. Open the tube cap and let water in the **emergency drain tube (C)** flow into the container.
6. When done, close the tube cap, and reinsert the tube. Then, close the filter cover.

Maintenance

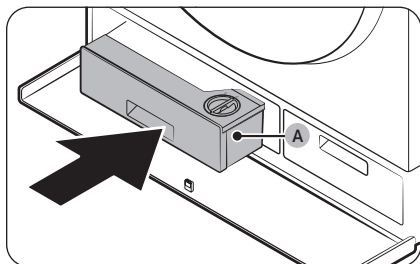

7. Insert the **Auto dispenser (A)** back into the place.
8. Close the Compartment cover.

NOTE

Use a spacious container because the water in the drum may be more than expected.

Cleaning

Surface of the Laundry Combo

Use a soft cloth with a nonabrasive household detergent. Do not spray water onto the Laundry Combo.

Mesh filter

Clean the mesh filter of the water hose once or twice a year.

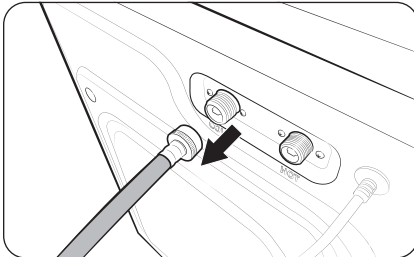

1. Turn off the Laundry Combo, and then unplug the power cord.
2. Close the water tap.
3. Loosen and disconnect the water hose from the back of the Laundry Combo. Cover the end of each hose with a cloth or towel to prevent water from gushing out.

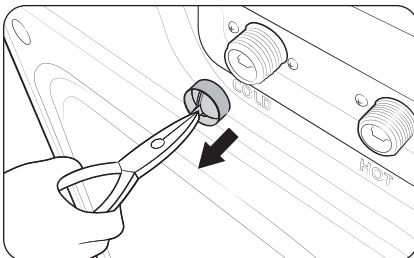

4. Use pliers to pull out the mesh filter from the inlet valve.
5. Submerge the mesh filter deeply in water so that the threaded connector is also submerged.
6. Dry the mesh filter completely in the shade.
7. Reinsert the mesh filter into the inlet valve, and reconnect the water hose to the inlet valve.
8. Open the water tap.

NOTE

- If the mesh filter is clogged, an information code of "4C" appears on the screen.
- Clean the mesh filter of the water hose more frequently if water is provided by an aged water system or well.

Maintenance

Drain filter

It is advisable to clean the drain filter every 2 months to prevent its clogging.

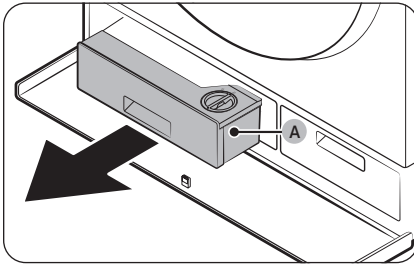

1. Turn off the Laundry Combo, and then unplug the power cord.
2. Drain the remaining water inside the drum. (For more information, see the **Emergency drain** section on page 63.)
3. Press the Compartment cover to open it.
4. Pull out the **Auto dispenser (A)**.

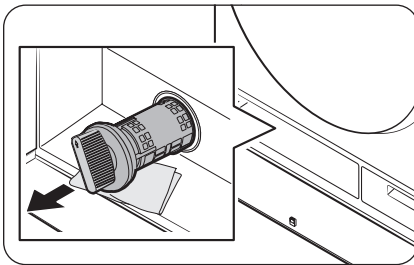

5. Turn the drain filter knob to the left, and drain off the remaining water.

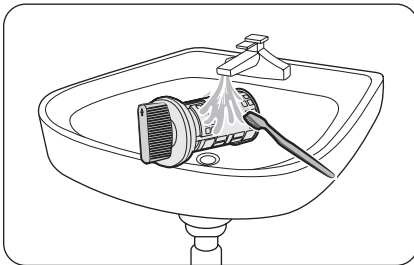

6. Clean the drain filter using a soft brush. While the drain filter is removed, make sure the impeller inside the drain pump is free of debris.

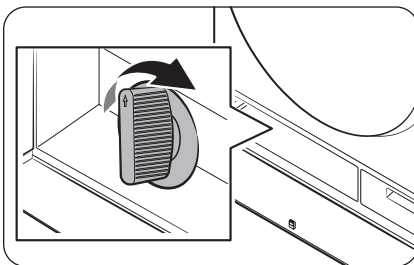

7. Reinsert the drain filter, and turn the filter knob to the right.

NOTE

Some drain filters feature a safety knob that is designed to prevent accidents by children. To open the safety knob of the drain filter, push in and turn it to the left. The spring mechanism of the safety knob helps open the filter.

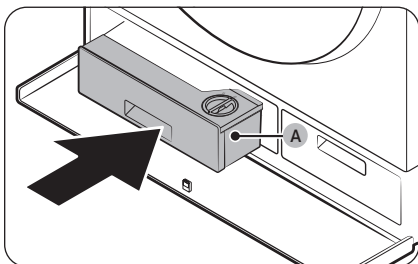

8. Insert the **Auto dispenser (A)** back into the place.
9. Close the Compartment cover.

NOTE

If the drain filter is clogged, an information code of "5C" appears on the screen.

CAUTION

- Make sure the filter knob is closed properly after cleaning the filter. Otherwise, this may cause a leak.
- Make sure the filter is inserted properly after cleaning it. Otherwise, this may cause an operational failure or a leak.

Maintenance

Auto dispensers

To prevent the detergent residue buildup in the automatic dispensers, clean the dispensers and their components once or twice a month, and whenever you refill or change the detergent or softener.

⚠ CAUTION

- Make sure to turn off the Laundry Combo and unplug the power cord before cleaning.
- If you are not going to use the Laundry Combo for a long time, empty the dispensers and clean them thoroughly.

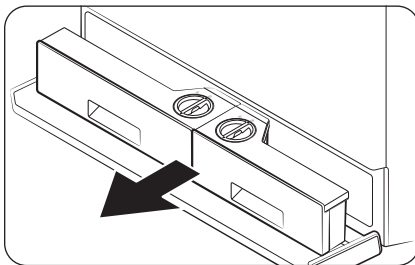

1. Press the Compartment cover to open it.
2. Pull out the Auto dispensers.

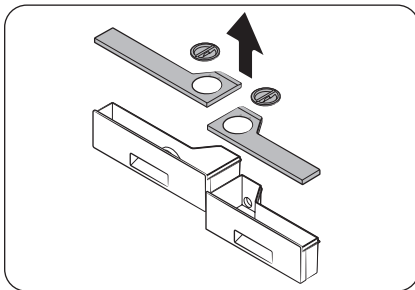

3. Remove the lids of both dispensers using the pull tabs at the back of each lid.

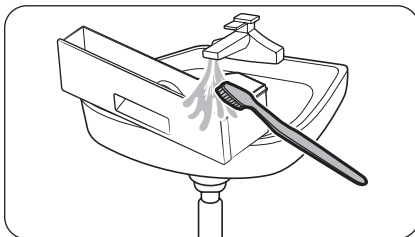

4. Clean the dispensers and all the other components under warm running water with a soft brush.
 - Wipe all components with a dry towel or cloth after cleaning

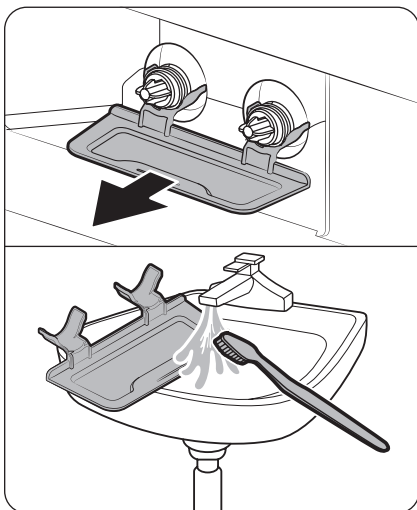

5. Remove the dispenser tray and clean it in running water to remove leaked detergent or softener. Then, put the tray back.

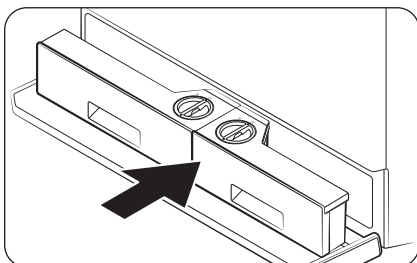

6. Push the Auto dispensers back into their positions.

⚠ CAUTION

- Make sure the dispenser recess is completely dry before inserting Auto dispensers.
- Tightly attach the tops of both dispensers before inserting them back.
- If the Compartment cover is not tightly closed, detergent may leak. Make sure the auto dispensers are fully pushed in.

7. Close the Compartment cover.

⚠ CAUTION

Do not spray water into the dispenser recess. This may result in electric shock or fire.

Maintenance

Door diaphragm

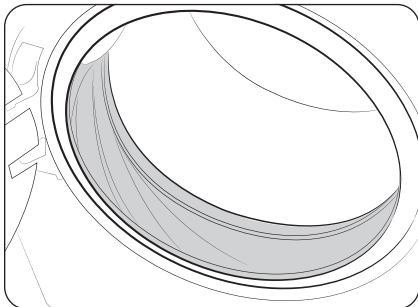

1. Open the door, and then empty the drum.
2. Combine 3/4 cups of liquid chlorine bleach and 1 gallon of warm tap water.
3. Wearing rubber gloves, use a soft, clean cloth dipped in the water and bleach solution to clean the diaphragm.
4. Let stand for 5 minutes, and then wipe up and dry well.

⚠ CAUTION

Use bleach carefully and be sure to follow the bleach manufacturer's use and care instructions.

Heat exchanger

A dirty heat exchanger will hinder the product's performance and should be cleaned regularly. An alert message appears every 180 uses to inform you to clean the heat exchanger. Clean the heat exchanger when you see the alert message.

NOTE

- Water droplets can form around the heat exchanger because of condensation caused by a temperature difference. This is normal and is not a sign of a leak.
- If you are not planning on using the Laundry Combo for a long period, open the Lint filter cover and ventilate.

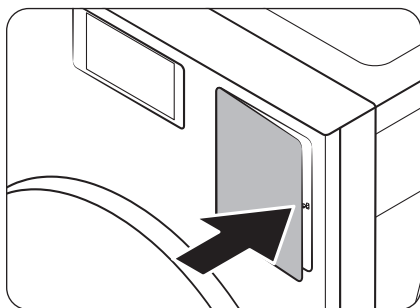

1. Press the right side of the Lint filter cover to open it.

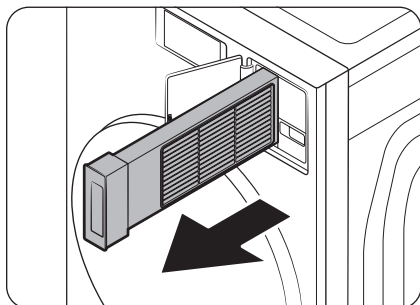

2. Pull out the lint filter.

Maintenance

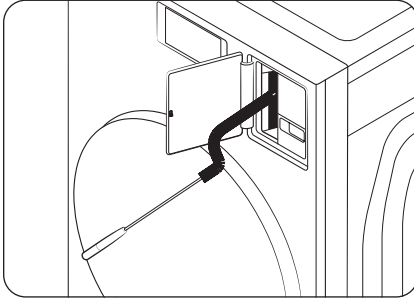

3. Clean the heat exchanger using an appliance brush.
 - After cleaning with a brush, using a vacuum with a crevice tool attachment will remove any other loose debris. Then wipe down the outer area with a damp cloth.

⚠ CAUTION

- To avoid physical injury and burns, do not touch or clean the heat exchanger with bare hands.
- When cleaning the heat exchanger, be careful not to damage the fins.

📖 NOTE

If the heat exchanger is difficult to clean because it is completely dry, spray some water onto it and use a brush to clean it.

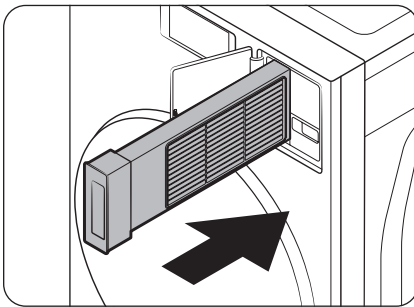

4. Insert the lint filter back into the place, and then close the Lint filter cover.

Lint filter

You must clean the lint filter every time after using the dry cycle. Not cleaning the lint filter could degrade the drying performance and affect the drying time.

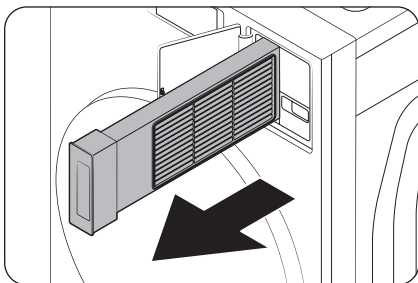

1. Open the Lint filter cover.
2. Pull out the lint filter.
 - Do not remove the rubber seal on the lint filter.

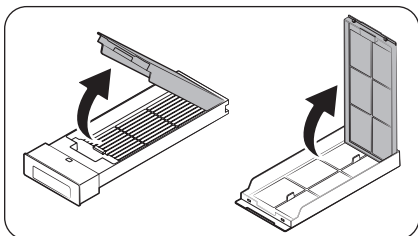

3. Open the outer filter, and then remove the inner filter.

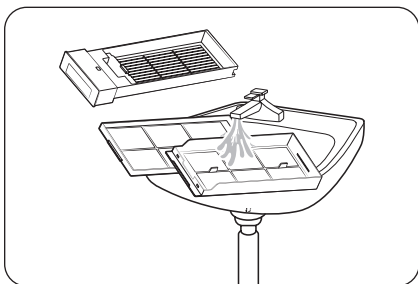

4. Remove lint on both inner and outer filters. Then, wash the filters in running water and completely dry the filters in a shade.

Maintenance

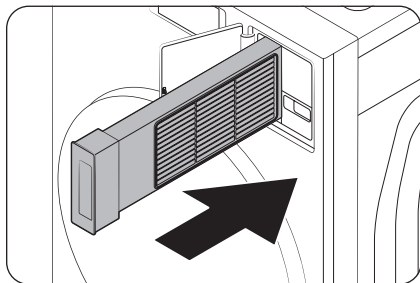

5. Put the inner filter into the outer filter in the correct direction.
6. Insert the assembled lint filter back into the place.

CAUTION

- Clean the lint filter after each load. Otherwise, the drying performance may decrease.
- If the filter surface is wet, allow it to completely dry before use.
 - Inserting the filter while it is wet may lead to the development of mold, unpleasant odors, or resulting in less efficient drying.
- When cleaning or removing the lint filter, do not shake or tap on the filter. Doing so can damage the filter.
- Opening the outer and inner filters carelessly and with excessive force can damage the filters.

NOTE

Water droplets can form around the heat exchanger because of condensation caused by a temperature difference. This is normal and is not a sign of a leak.

Defrosting your washing machine

The Laundry Combo may freeze when the temperature in its location drops below 0 °C.



1. Turn off the Laundry Combo, and then unplug the power cord.
2. Pour warm water over the water tap to loosen the water hose.
3. Disconnect the water hose, and then soak it in warm water.
4. Pour warm water into the drum and leave it for about 10 minutes.
5. Reconnect the water hose to the water tap.

NOTE

If the Laundry Combo still doesn't operate normally, repeat the steps above.

Care against an extended time of disuse

Avoid leaving the Laundry Combo unused for an extended time. However, if you intend to leave the Laundry Combo unused for a long period of time, follow the directions below:

1. Tap .
2. On the Cycle screen, select **Rinse+Spin**.
3. Empty the drum, and then tap and hold .
4. When the cycle is complete, close the water taps and disconnect the water hoses.
5. Turn off the Laundry Combo, and then unplug the power cord.
6. Open the door to let air circulate through the drum.

Troubleshooting

If a problem persists, contact a service center. The number of the service center is on the label attached to the product.

Checkpoints

If you encounter a problem with the Laundry Combo, first check the table below and try these suggestions.

Problem	Action
Does not start.	<ul style="list-style-type: none">• Make sure the Laundry Combo is plugged in.• Make sure the door is properly closed.• Make sure the water taps are open.• Tap  to start the Laundry Combo.• Make sure Lock is not activated.• Before the Laundry Combo starts to fill, it will make a series of clicking noises to check the door lock and will do quick drain.• Check the fuse or reset the circuit breaker.• Check if power is supplied properly.• Low voltage detected.<ul style="list-style-type: none">– Check if the power cord is plugged in.• Make sure laundry is not caught in the door.• Clean the filter.
Water supply is insufficient, or no water is supplied.	<ul style="list-style-type: none">• Fully open the water tap.• Make sure the door is properly closed.• Make sure the water supply hose is not frozen.• Make sure the water supply hose is not kinked or clogged.• Make sure there is sufficient water pressure.• Make sure that the cold water tap and the hot water tap are properly connected.• Clean the mesh filter as it may be clogged.
After a cycle, detergent remains in the detergent drawer.	<ul style="list-style-type: none">• Make sure the Laundry Combo is running with sufficient water pressure.• Make sure the detergent is added to the center of the detergent drawer.• Make sure the rinse cap is inserted properly.• If using granular detergent, make sure the detergent selector is in the upper position.• Remove the rinse cap and clean the detergent drawer.

Problem	Action
<p>Excessive vibrations or makes noise.</p>	<ul style="list-style-type: none"> • Make sure the Laundry Combo is installed on a level, solid floor that is not slippery. If the floor is not level, use the leveling feet to adjust the height of the Laundry Combo. • Make sure the shipping bolts are removed. • Make sure the Laundry Combo is not in contact with any other object. • Make sure the laundry load is balanced. • The motor can cause noise during normal operation. • Overalls or clothes with metallic decorations can cause noise while being washed. This is normal. • Metal objects such as coins can cause noise. After washing, remove these objects from the drum or filter case. • The spinning process is not performing properly because there is not enough laundry or the load is unbalanced. <ul style="list-style-type: none"> - Add more laundry or redistribute the items, then tap Start to restart the washer. Or, turn off the product and turn it back on after 2-3 minutes, then try again. • Remove any items stuck inside the lint filter.
<p>Does not drain and/or spin.</p>	<ul style="list-style-type: none"> • Make sure the drain hose is not kinked between the unit and drain system. If you encounter a drain problem, call for service. • Make sure the drain filter is not clogged. • Close the door and tap and hold ▷ . <p>For your safety, the Laundry Combo will not tumble or spin unless the door is closed.</p> <ul style="list-style-type: none"> • Make sure the drain hose is not frozen or clogged. • Make sure the drain hose is connected to a drain system that is not clogged. • If the Laundry Combo is not supplied with sufficient power, the Laundry Combo will temporarily not drain or spin. As soon as the Laundry Combo regains sufficient power, it will operate normally. • Make sure the drain hose is positioned correctly, depending on the connection type. • Clean the drain filter as it may be clogged.

Troubleshooting

Problem	Action
The door does not open.	<ul style="list-style-type: none"> • Tap ▷ to stop the Laundry Combo. • It may take a few moments for the door lock mechanism to disengage. • The door will not open until 3 minutes after the Laundry Combo has stopped or the power has been off. • Make sure all the water in the drum is drained. • The door may not open if water remains in the drum. Drain the drum and open the door manually. • Make sure the door lock light is off. The door lock light turns off after the Laundry Combo has drained. • Power Off and restart the unit.
Excessive suds.	<ul style="list-style-type: none"> • Make sure you use the recommended types of detergent as appropriate. • Use high efficiency (HE) detergent to prevent oversudsing. • Reduce the detergent amount for soft water, small loads, or lightly soiled loads. • Non-HE detergent is not recommended.
Cannot add additional detergent.	<ul style="list-style-type: none"> • Make sure the remaining amount of detergent and fabric softener is not over the limit.
Stops.	<ul style="list-style-type: none"> • Plug the power cord into a live electrical outlet. • Check the fuse or reset the circuit breaker. • Close the door, and tap and hold ▷ to start the Laundry Combo. For your safety, the Laundry Combo will not tumble or spin unless the door is closed. • Before the Laundry Combo starts to fill, it will make a series of clicking noises to check the door lock and will do quick drain. • There may be a pause or soak period in the cycle. Wait briefly, and the Laundry Combo may start. • Make sure the mesh filter of the water supply hose at the water taps is not clogged. Periodically clean the mesh filter. • If the Laundry Combo is not supplied with sufficient power, the Laundry Combo will temporarily not drain or spin. As soon as the Laundry Combo regains sufficient power, it will operate normally.

Problem	Action
Fills with the wrong water temperature.	<ul style="list-style-type: none"> • Fully open both taps. • Make sure the temperature selection is correct. • Make sure the hoses are connected to the correct taps. Flush water lines. • Make sure the water heater is set to supply a minimum of 49 °C hot water at the tap. Also, check the water heater capacity and recovery rate. • Disconnect the hoses and clean the mesh filter. The mesh filter may be clogged. • While the Laundry Combo fills, the water temperature may change as the automatic temperature control feature checks incoming water temperature. This is normal. • While the Laundry Combo fills, you may notice just hot and/or just cold water going through the dispenser when cold or warm temperatures are selected. This is a normal function of the automatic temperature control feature as the Laundry Combo determines the water temperature.
Load is wet at the end of a cycle.	<ul style="list-style-type: none"> • Use the High or Extra High spin speed. • Use high efficiency (HE) detergent to reduce oversudsing. • Load is too small. Small loads (one or two items) may become unbalanced and not spin completely. • Make sure the drain hose is not kinked or clogged.
Leaks water.	<ul style="list-style-type: none"> • Make sure the door is properly closed. • Make sure all hose connections are tight. • Make sure the end of the drain hose is correctly inserted and secured to the drain system. • Avoid overloading. • Use high efficiency (HE) detergent to prevent oversudsing. • Check the drain hose. <ul style="list-style-type: none"> - Make sure the end of the drain hose is not placed on the floor. - Make sure the drain hose is not clogged.
Items still wrinkled after Wrinkle Prevent (Wrinkle Away, Wrinkle Release)	<ul style="list-style-type: none"> • Small loads of 1 to 4 items work best. • Load fewer items. Load similar-type items. • Take out the items immediately after drying is complete.

Troubleshooting

Problem	Action
<p>The clothes have lint on them.</p>	<ul style="list-style-type: none"> • Always make sure the lint filter is clean before putting items into the Laundry Combo. When drying items that generate a large amount of lint, you may need to clean the lint filter in the middle of a cycle. • Some fabrics (such as white towels) causes more lint and should be dried separately from fabrics that lint attaches easily (such as black linen pants). • Check the inside of the pockets to make sure they are empty before drying.
<p>Items are not dried.</p>	<p>Check all of the above. Additionally:</p> <ul style="list-style-type: none"> • Do not overload the Laundry Combo. If the Laundry Combo is overloaded, it could take longer for items to dry. • Dry heavy fabrics separately from light fabrics. • The item(s) are too small and may not get enough spinning inside the drum. • Clean the filter. • Clean the heat exchanger. • If a drain hose is connected, make sure the water is draining properly.
<p>Items are not dried evenly.</p>	<ul style="list-style-type: none"> • Seams, pockets, and other parts of clothing are harder to dry than others. This is normal. • Sort heavy and light items separately.
<p>Has odors.</p>	<ul style="list-style-type: none"> • Excessive suds collect in recesses and can cause foul odors. • Run cleansing cycles to sanitise periodically. • Clean the door seal (diaphragm). • Do not attempt to dry wet items after leaving them in the Laundry Combo for a long time. • The Laundry Combo circulates ambient air inside and outside during the drying process to cool the system. Using the drying in a poorly ventilated area may, depending on the operating environment, raise the ambient humidity level and cause a damp, soggy smell to develop. Ensure proper ventilation when using the drying. • Dry the interior of the Laundry Combo after a cycle has finished.
<p>A message appears on the display to alert that dispenser is open.</p>	<ul style="list-style-type: none"> • Check if the detergent drawer is closed properly. <ul style="list-style-type: none"> - Open the detergent drawer and close it again. Make sure it's closed properly.

Problem	Action
The "Needs refill" message does not disappear after refilling the detergent/softener.	<ul style="list-style-type: none"> After refilling the Auto dispenser and Flex auto dispenser, close the detergent drawer, and then tap and hold ▷ . Then, the Laundry Combo will start to detect the detergent/softener, and the message will disappear. Depending on the type of detergent/softener, the message may not disappear immediately.
Detergent/softener is not dispensed.	<ul style="list-style-type: none"> Check if the Amount option for Auto dispenser or Flex auto dispenser is set to Off. The automatic dispensers do not dispense the detergent if the option is set to Off. Tap Settings, select Auto dispenser or Flex auto dispenser, and then change the Amount option. The automatic dispensers are disabled in the Delicates, Activewear, or Wool cycles. To dispense detergent in those cycles, tap Settings, select Auto dispenser or Flex auto dispenser, and then change the Amount option.
Excessive or insufficient amount of detergent/softener is dispensed.	<ul style="list-style-type: none"> Check the Amount option for Auto dispenser or Flex auto dispenser. Tap Settings, select Auto dispenser or Flex auto dispenser, and then change the Amount option.
Screen retention occurs while using the LCD screen.	<ul style="list-style-type: none"> When the temperature around the Laundry Combo is low, screen retention may occur while using the LCD. It will function normally when the temperature rises.

- If a problem persists, contact a service center. The number of the service center is on the label attached to the product.
- Samsung is not liable for any damage to the product, any injury, or any other product safety issue caused by a repair which does not follow the instructions in these Repair Guides. Any damage to the product caused by an attempted repair (by anyone other than a Samsung certified service provider) will also not be covered by the warranty.

CAUTION

Defrosting your washing machine: The washing machine may freeze when it drops below 0 °C.

- Turn off the washing machine, and unplug the power cord.
- Pour warm water over the water tap to loosen the water hose.
- Disconnect the water hose, and soak it in warm water.
- Pour warm water into the drum and leave it for about 10 minutes.
- Reconnect the water hose to the water tap.

Troubleshooting

Information codes

If there is any problem, check the information message on the LCD screen and follow the on-screen instructions.

Problem	Code	Action
Check drainage	5C	<ul style="list-style-type: none"> The Laundry Combo isn't draining properly. Clean the drain filter, then tap Start to restart the Laundry Combo. Or, turn it off and on again after 2-3 minutes, then try again. <p>NOTE</p> <p>If you perform the Condenser Cleaning function without connecting the water supply hose, you may see the 5C code on the LCD display. In this case, please check the drainage and water supply status.</p>
Check water supply	4C	<ul style="list-style-type: none"> Water isn't being supplied properly. Check the faucets, then tap Start to restart the Laundry Combo. Or, turn it off and on again after 2-3 minutes, then try again.
Please connect the hot/cold water hose connection correctly	4C2	<ul style="list-style-type: none"> The water is too hot. Some fabrics need to be protected. Check if the water supply hoses are properly connected, then tap Start to restart the Laundry Combo. Or, turn it off and on again after 2-3 minutes, then try again.
Incorrect button state	BC2	<ul style="list-style-type: none"> A button on the Laundry Combo is still pressed in. Turn off the Laundry Combo, then turn it on again after 2-3 minutes and try again.
Open the door and evenly distribute the load	UB	<ul style="list-style-type: none"> The spinning process is not performing properly because there is not enough laundry or the load is unbalanced. <ul style="list-style-type: none"> Add more laundry or redistribute the items, then tap Start to restart the washer. Or, turn it off and on again after 2-3 minutes, then try again.
Waterproof items detected	UB1	<ul style="list-style-type: none"> Your laundry contains waterproof items. Remove those items, then tap Start to restart the Laundry Combo. Or, turn it off and on again after 2-3 minutes, then try again.
Door is open	DC	<ul style="list-style-type: none"> The door is open. Close it and try again.
Close the washer door and try again	DC6	<ul style="list-style-type: none"> Auto Open Door isn't working properly. If you turn off the power, the door will open. To use Auto Open Door, turn off Lock and Smart Control in SmartThings.

Problem	Code	Action
The door switch lock/ unlock is not working properly.	DC1	<ul style="list-style-type: none"> Turn off the Laundry Combo, then turn it on again after 2-3 minutes and try again.
		<ul style="list-style-type: none"> The door switch isn't working properly. Check for foreign substances around the door, then push the door closed and try again.
Check filter is inserted correctly	NC	<ul style="list-style-type: none"> Check if the filter is inserted correctly, then tap Start to restart the Laundry Combo. Or, turn it off and on again after 2-3 minutes, then try again.

If any information code keeps appearing on the screen, contact a local Samsung service center.

Specifications

Fabric care chart

The following symbols provide garment care direction. The Clothing care labels include symbols for drying, bleaching, drying and ironing, or dry cleaning when necessary. The use of symbols ensures consistency among garment manufacturers of domestic and imported items. Follow care label directions to maximize garment life and reduce laundering problems.

Washing

	95 °C normal wash.
	60 °C normal wash.
	60 °C mild wash.
	40 °C normal wash.
	40 °C mild wash.
	40 °C very mild wash.
	30 °C normal wash.
	30 °C mild wash.
	30 °C very mild wash.
	Hand wash.
	Do not wash.

NOTE

The numbers in the wash tub specify the maximum washing temperatures in degrees celsius which must not be exceeded.

Bleaching

	Any bleach allowed.
	Only oxygen bleach allowed.
	Do not bleach.





Drying

	Tumble drying / normal temperature / maximum exhaust temperature 80 °C.
	Tumble drying / lower temperature / maximum exhaust temperature 60 °C.
	Do not tumble dry
	Line drying.
	Drip line drying.
	Flat drying.
	Drip flat drying.
	Line drying in the shade.
	Drip line drying in the shade.
	Flat drying in the shade.
	Drip flat drying in the shade.

NOTE

- The dots indicate the drying level of the dryer.
- The lines indicate the type and place of the drying.



Ironing







	Iron at maximum sole plate temperature of 200 °C.
	Iron at maximum sole plate temperature of 150 °C.
	Iron at maximum sole plate temperature of 110 °C. Caution when using steam irons (work without steam).
	Do not iron.

NOTE

The dots indicate the temperature ranges for ironing (regulator, steam, travel irons and ironing machines).

Professional care

	Professional dry-cleaning in perchloroethylene and/or hydrocarbons (heavy benzines) with normal process.
	Professional dry-cleaning in perchloroethylene and/or hydrocarbons (heavy benzines) with gentle process.

	Professional dry-cleaning in hydrocarbons (heavy benzines) with normal process.
	Professional dry-cleaning in hydrocarbons (heavy benzines) with gentle process.
	Do not dry-clean.
	Professional wet-cleaning.
	Mild professional wet-cleaning.
	Very mild professional wet-cleaning.
	Do not wet-clean.

NOTE

- The letters in a circle indicate the solvents (P, F) used in dry cleaning or wet cleaning (W).
- Generally, the line under the symbol indicates a milder treatment (e.g. gentle cycle for easy-care items). The double line indicates care levels with particularly gentle treatment.

Protecting the environment

- This appliance is manufactured from recyclable materials. If you decide to dispose of it, please observe local waste disposal regulations. Cut off the power cord so that the appliance cannot be connected to a power source. Remove the lid so that animals and small children cannot get trapped inside the appliance.
- Do not exceed the detergent quantities recommended in the detergent manufacturers' instructions.
- Use stain removal products and bleaches before the wash cycle only when necessary.
- Save water and electricity by only washing full loads (the exact amount depends upon the program used).

Specifications

Standby power consumption

Power consumption	Off mode	0.50 W
	Network standby mode	2.00 W
	Time in networked standby mode (WI-FI)	10 min

Refrigerant safety precautions

Contains fluorinated greenhouse gases.

Hermetically sealed equipment.

Do not vent gases into the atmosphere.

- Refrigerant (Type): R-134a (GWP = 1430)

Spare parts guarantee

We guarantee that the following spare parts will be available to professional repairers and end-users for a minimum period of 10 years after placing the last unit of the model on the market.

- Door, door hinges and seals, other seals, door locking assembly, and plastic peripherals such as detergent dispensers.
- Listed parts can be purchased at below website.
 - <http://www.samsung.com/support>

Specification sheet

"*" Asterisk(s) means variant model and can be varied (0-9) or (A-Z).

Type		Front loading washing machine	
Model name		WD18DB8995**	
Dimensions	A (Width)	686 mm	
	B (Height)	1110 mm	
	C (Depth)	875 mm	
Water pressure		50-1000 kPa	
Net weight		147.0 kg	
Maximum load capacity		Washing and spinning	18.0 kg
		Drying	11.0 kg
Power consumption	Washing and heating	AC 220-240 V / 50 Hz	2000-2400 W
	Dry	AC 220-240 V / 50 Hz	1000 W
Spin revolutions		1000 RPM	

NOTE

- The design and specifications are subject to change without notice for quality improvement purposes.
- The dimensions stated here may differ slightly from the actual measurements depending on the measuring method.

Specifications

Indicative information (According to EU 2019/2023)

Model	Cycles	Capacity (kg)	Program Time (HH:MM)	Energy Consumption (kWh/Cycle)	Water Consumption (L/cycle)	Maximum Temperature (°C)	Remaining Moisture Content (%)	Spinning Speed (RPM)
WD18DB8995**	ECO 40-60	18.0	4:00	2.500	200.0	46	53.9	951
		9.0	3:00	0.818	94.0	28	53.9	1049
		4.5	3:00	0.385	66.5	26	53.9	1049
	Wash+Dry	11.0	8:43	2.822	110.0	28	-	1049
		5.5	6:11	1.500	78.0	26	-	1049
	Cotton 20 °C	18.0	1:50	0.280	102.0	20	62.0	951
	Cotton 60 °C	18.0	1:55	1.750	125.0	60	62.0	951
	Cotton 60 °C+ Bubble Soak	18.0	2:25	2.700	125.0	60	62.0	951
	Shirts	5.0	0:37	0.150	60.0	20	62.0	1049
	Super Speed	5.0	0:37	0.150	60.0	20	62.0	1049

- The values given for programmes other than the ECO 40-60 programme and the wash and dry cycle are indicative only.
- The time values stated here may differ from the actual values due to the influence of the water pressure/hardness/temperature, type/amount/soiling level of the laundry, type/amount of the detergent used, power supply, and the selected additional functions.

EPREL information

To access energy labelling information about this product on the European Product Registry for Energy Labelling (EPREL), go to https://eprel.ec.europa.eu/qr/***** where ***** is the product's EPREL registration number. You can find the registration number on the rating label of your product.

Contact information

QUESTIONS OR COMMENTS?

COUNTRY	CALL	OR VISIT US ONLINE AT
UK	0333 000 0333	www.samsung.com/uk/support
IRELAND (EIRE)	0818 717100	www.samsung.com/ie/support
GERMANY	06196 77 555 77	www.samsung.com/de/support
FRANCE	01 48 63 00 00	www.samsung.com/fr/support
SPAIN	91 175 00 15	www.samsung.com/es/support
PORTUGAL	210 608 098 Chamada para a rede fixa nacional Dias úteis das 9h às 20h	www.samsung.com/pt/support
LUXEMBURG	261 03 710	www.samsung.com/be_fr/support
NETHERLANDS	088 90 90100	www.samsung.com/nl/support
BELGIUM	02-201-24-18	www.samsung.com/be/support (Dutch) www.samsung.com/be_fr/support (French)
NORWAY	21 62 90 99	www.samsung.com/no/support
DENMARK	70 70 19 70	www.samsung.com/dk/support
FINLAND	030-622 75 15	www.samsung.com/fi/support
SWEDEN	0771-400 300	www.samsung.com/se/support
AUSTRIA	0800 72 67 864 (0800-SAMSUNG)	www.samsung.com/at/support
SWITZERLAND	0800 726 786	www.samsung.com/ch/support (German) www.samsung.com/ch_fr/support (French)
HUNGARY	0680SAMSUNG (0680-726-7864)	www.samsung.com/hu/support
CZECH	800 - SAMSUNG (800-726786)	www.samsung.com/cz/support
SLOVAKIA	0800 - SAMSUNG (0800-726 786)	www.samsung.com/sk/support
CROATIA	072 726 786	www.samsung.com/hr/support
BOSNIA	055 233 999	www.samsung.com/ba/support
North Macedonia	023 207 777	www.samsung.com/mk/support
MONTENEGRO	020 405 888	www.samsung.com/support
SLOVENIA	080 697 267 (brezplačna številka)	www.samsung.com/si/support
SERBIA	011 321 6899	www.samsung.com/rs/support

Contact information

COUNTRY	CALL	OR VISIT US ONLINE AT
Kosovo	038 40 30 90	www.samsung.com/support
ALBANIA	045 620 202	www.samsung.com/al/support
BULGARIA	0800 111 31 - Безплатен за всички оператори *3000 - Цена на един градски разговор или според тарифата на мобилният оператор 09:00 до 18:00 - Понеделник до Петък	www.samsung.com/bg/support
ROMANIA	0800872678 - Apel gratuit *8000 - Apel tarifat în rețea Program Call Center Luni - Vineri: 9 AM - 6 PM	www.samsung.com/ro/support
ITALIA	800-SAMSUNG (800.7267864)	www.samsung.com/it/support
CYPRUS	8009 4000 only from landline, toll free	www.samsung.com/gr/support
GREECE	80111-SAMSUNG (80111 726 7864) from mobile and land line (+30) 210 6897691 from mobile and land line	
POLAND	801-172-678* * (opłata według taryfy operatora)	http://www.samsung.com/pl/support/
LITHUANIA	8-800-77777	www.samsung.com/lt/support
LATVIA	8000-7267	www.samsung.com/lv/support
ESTONIA	800-7267	www.samsung.com/ee/support

Memo

SAMSUNG